



TERRAZZO-WARE™



**MOP SINKS
SHOWER BASES**

ACORN ENGINEERING COMPANY

Acorn Engineering Company continues its 40 year tradition of setting industry standards. Our adherence to strict quality control measures ensures that our customers receive the best plumbing fixtures available.

The Acorn family of products has grown substantially over the years. Our plumbing fixtures can be found in hospitals, schools, correctional facilities, industrial, corporate and sports complexes. We manufacture stainless steel showers, sinks, toilets, lavatories, bedside toilet/lavatory cabinet systems for intensive care units, surgical scrub sinks, washfountains, in addition to our complete line of terrazzo mop sinks and shower bases.



ACORN'S TERRAZZO LAVS™
(Washfountains)

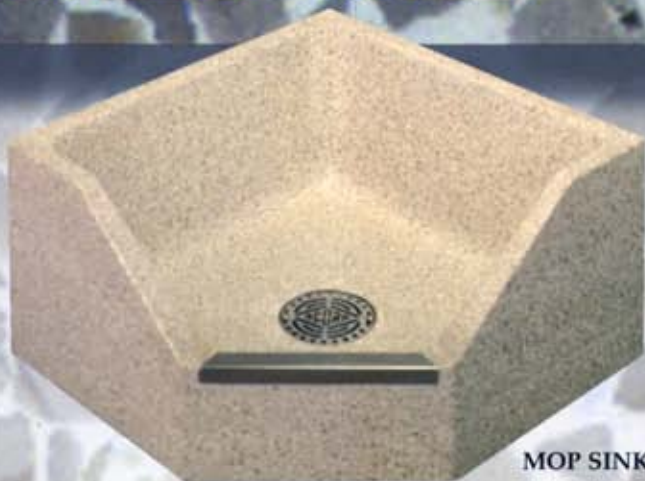

MOP SINK

AVAILABLE COLORS:



PALOMINO TAN
(Standard)



HYBRID ROSE
(Optional)



PLATINUM GRAY
(Optional)



MIDNIGHT ROSE
(Optional)

Acorn's line of *Terrazzo-Ware™* is joined by two products, each designed to perform specific tasks. The **Mop Sink** is a versatile, easy to maintain sanitation and cleaning station. Terrazzo's natural surface provides years of dependable service. Mop Sinks are available in a variety of sizes, colors and configurations.

The *Terrazzo-Ware Shower Base* is spacious in design and easy to maintain. Formed with coved corners and pitched floors, Shower Bases are easy to keep clean and sanitary. Terrazzo Shower Bases are offered in several different sizes, colors and configurations, designed to fit the needs of your specific facility, including ADA (Americans With Disabilities Act) compliant facilities.

Acorn selected Terrazzo as the primary construction material for its line of Mop Sinks and Shower Bases because of Terrazzo's unique ability to be attractive, incredibly strong and durable. Both Mop Sinks and Shower Bases are constructed with one-piece, pre-cast Terrazzo composed of marble chips and Portland cement. The Terrazzo surface is then ground smooth and sealed for years of durable service. Mop Sinks and Shower Bases feature coved corners and pitched floors for positive drainage. Acorn offers a full line of options and accessories to complement and complete each installation.

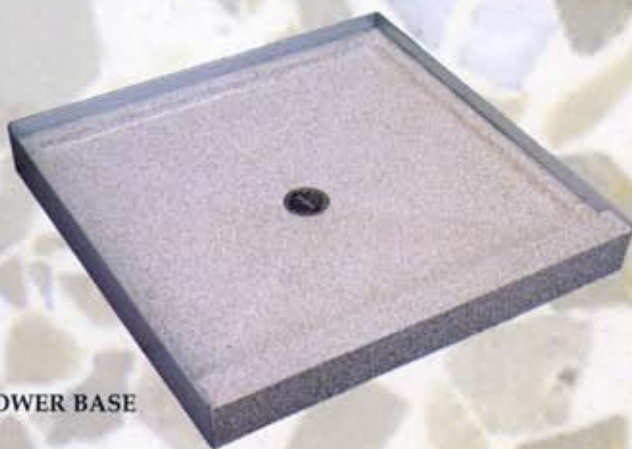

SHOWER BASE

TERRAZZO-WARE MOP SINKS

Reduced Height Series

Terrazzo Reduced Height (TRH) mop sinks provide attractive cost effective solutions. They come standard with a stainless steel grid strainer and provide for a 3" inside caulk waste pipe connection. A beehive dome strainer is also available.

TRH-242410
Terrazzo Reduced Height



TRH-362410
Terrazzo Reduced Height



TRH-363606
Terrazzo Reduced Height



OPTIONS



-BDS
Beehive
Dome
Strainer

Standard Height Series

Terrazzo Standard Height (TSH) mop sinks are available in a variety of sizes. These popular 12" high models come standard with a stainless steel grid strainer, a 3" inside caulk drain and plain shoulders which enhances Terrazzo's natural beauty. Also available are custom sizes, colors and a stainless steel cap that provides chip resistance for a longer life.

TSH-24
Terrazzo Standard Height



TSH-36-SSC
Terrazzo Standard Height
with Stainless Steel Cap



OPTIONS

-SSC
Stainless Steel
Cap



-BDS
Beehive
Dome
Strainer

-OC
Optional
Colors (see
page 2)

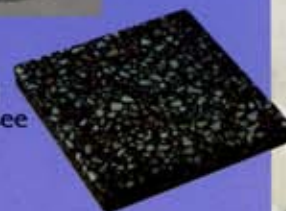

-CRS
Chemical Resistant Sealant

-TF
Tiling Flanges, factory
Installed (contact factory)



Terrazzo Reduced Height Mop Sinks

MODEL NUMBER	TYPE	SIZES / DIMENSIONS				
		A - LENGTH	B - WIDTH	C	D	E- HEIGHT
TRH-242410	Square	24" (610mm)	24" (610mm)	-	-	10" (254mm)
TRH-362410	Rectangular	36" (914mm)	24" (610mm)	-	-	10" (254mm)
TRH-242406	Square	24" (610mm)	24" (610mm)	-	-	6" (152mm)
TRH-303006	Square	30" (762mm)	30" (762mm)	-	-	6" (152mm)
TRH-323206	Square	32" (813mm)	32" (813mm)	-	-	6" (152mm)
TRH-363606	Square	36" (914mm)	36" (914mm)	-	-	6" (152mm)
TRH-363606-NC	Neo-Corner	36" (914mm)	36" (914mm)	17" (432mm)	26 1/4" (683mm)	6" (152mm)
TRH-362406	Rectangular	36" (914mm)	24" (610mm)	-	-	6" (152mm)

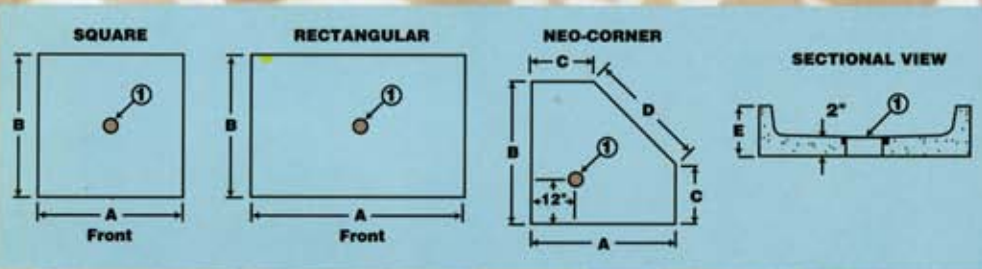

NOTE:
① Drain, 3" IC (Inside Caulk Outlet), centered in square and rectangular fixtures.

Terrazzo Standard Height Mop Sinks

MODEL NUMBER	TYPE	SIZES / DIMENSIONS	
		A - LENGTH	B - WIDTH
TSH-24	Square	24" (610mm)	24" (610mm)
TSH-32	Square	32" (813mm)	32" (813mm)
TSH-36	Square	36" (914mm)	36" (914mm)
TSH-3624	Rectangular	36" (914mm)	24" (610mm)

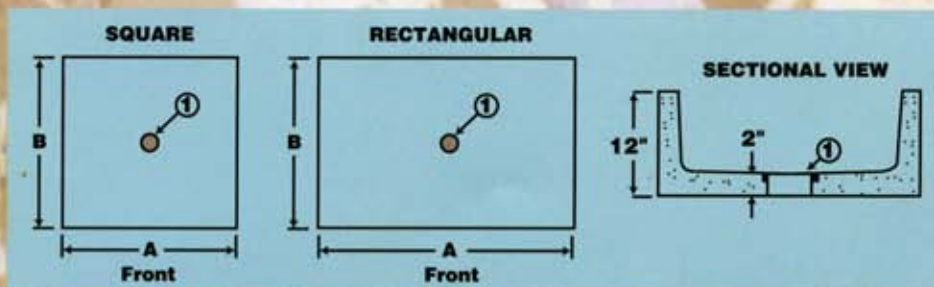

NOTE:
① Drain, 3" IC (Inside Caulk Outlet), centered within fixtures.

ACCESSORIES



KBGV
Bumper Guards,
Vinyl
KBGS
Bumper Guards,
Stainless Steel

KFC
Faucet,
Chrome finish
(H&C)



KF
Tiling Flanges,
shipped loose
(KF24" shown
installed)



KWG
Stainless steel
Wall Guards,
shipped loose
(KWG2-24"
shown)



KMH
Mop Hanger
with 3 grips on
stainless steel
wall bracket



KH36
36" Hose
with wall
hanger



KDG3 & KDG32
Rubber Drain
Gaskets for 3" or
2" waste pipe



TERRAZZO-WARE MOP SINKS

Corner Series



TCR-28
Terrazzo
Corner Round



TNC-24
Terrazzo
Neo-Corner

Terrazzo Corner Round (TCR) and Terrazzo Neo-Corner (TNC) configurations provide an alternative for those installations where a corner drain requires a flexible fixture. A stainless steel cap on the dropped front of the fixture protects the Terrazzo from chipping. A 3" inside caulk drain and stainless steel grid strainer are also provided. Custom colors are available.



TCR-28"
Terrazzo Corner Round shown with **KWG2-28"** double stainless steel Wall Guard



TNC-24
Terrazzo Neo-Corner shown with **KF24"**, 2 field installed tiling Flanges

Drop Front Series



TDF-24
Terrazzo Drop Front

Terrazzo Drop Front (TDF) mop sinks provide easy front access. A stainless steel cap mounted on the dropped front protects the Terrazzo from chipping. A 3" inside caulk drain and stainless steel grid strainer is also provided.

OPTIONS

-SSC
Stainless Steel
Cap



-BDS
Beehive Dome
Strainer

-OC
Optional Colors
(see page 2)

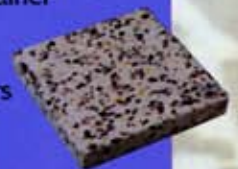

-CRS
Chemical Resistant Sealant

-TF
Tiling Flanges, factory
installed (contact factory)



Terrazzo Corner Series Mop Sinks

MODEL NUMBER	TYPE	SIZES / DIMENSIONS			
		A - LENGTH	B - WIDTH	C	D
TCR-28	Corner Round	28" (711mm)	28" (711mm)	-	-
TNC-24	Neo-Corner	24" (610mm)	24" (610mm)	15" (381mm)	12 1/4" (324mm)
TNC-32	Neo-Corner	32" (813mm)	32" (813mm)	15" (381mm)	24" (611mm)
TNC-36	Neo-Corner	36" (914mm)	36" (914mm)	17" (432mm)	26 1/4" (683mm)

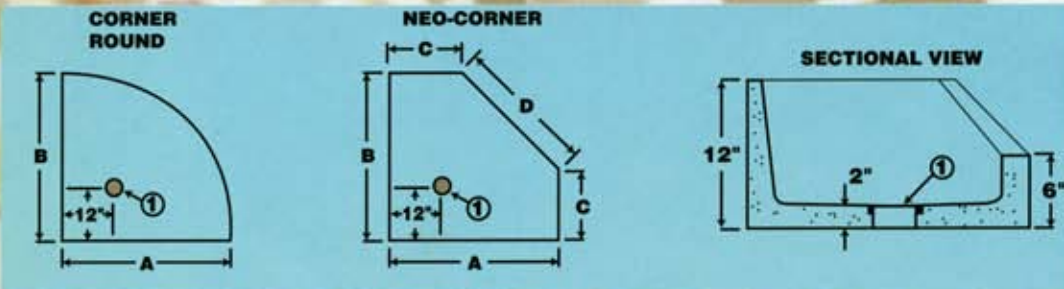

NOTE:
① Drain, 3" IC (Inside Caulk Outlet)

OPTIONS



-BDS
Beehive
Dome
Strainer

-OC
Optional Colors (see
page 2)

-CRS
Chemical Resistant Sealant



-SSC
Stainless
Steel Cap
(requires
-SH option)

-SH
Standard Height, all five sides
are 12" high (TNC models only)

-TF
Tiling Flanges, factory
installed (contact factory)

ACCESSORIES



KF
Tiling Flanges,
shipped loose
(KF24" shown
installed)

KFC
Faucet,
Chrome
finish (H&C)



KWG
Stainless steel
Wall Guards,
shipped loose
(KWG2-24"
shown)

KMH
Mop
Hanger with
3 grips on
stainless
steel wall
bracket



Terrazzo Drop Front Mop Sinks

MODEL NUMBER	TYPE	SIZES / DIMENSIONS	
		A - LENGTH	B - WIDTH
TDF-24	Square	24" (610mm)	24" (610mm)
TDF-32	Square	32" (813mm)	32" (813mm)
TDF-36	Square	36" (914mm)	36" (914mm)
TDF-3624	Rectangular	36" (914mm)	24" (610mm)

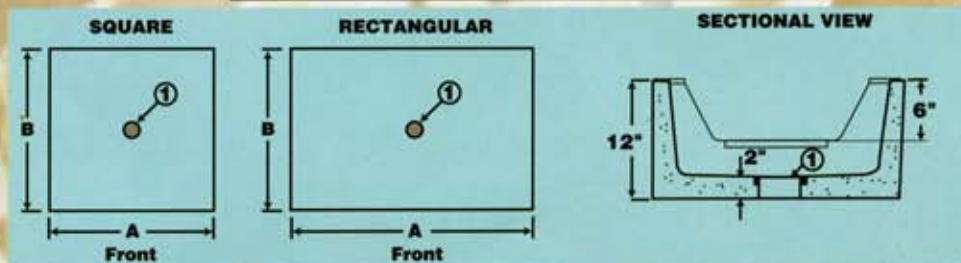

NOTE:
① Drain, 3" IC (Inside Caulk Outlet), centered within fixtures.

All Terrazzo Mop Sinks and Shower Bases must be installed with 1/4" clearance between mop sink or shower base and building wall and set in a layer of mortar between base and building floor to ensure that the mop sink or shower base can be leveled. Dimensions are subject to manufacturer's tolerance of plus or minus 1/4" and may change without notice. Acorn Engineering Co. assumes no responsibility for use of void or superseded data.



KH36
36" Hose
with wall
hanger

KDG3 & KDG32
Rubber Drain
Gaskets for 3"
or 2" waste pipe



TERRAZZO-WARE SHOWER BASES

Integral Threshold Series

Integral Threshold entrance and two or three flanged sides (-2F, -3F) distinguish this broad line of attractive, spacious and durable Shower Bases offered in Corner (SBC), Square (SBS) and Rectangular (SBR) configurations. The Integral Threshold entrance allows for installation of a shower door. The shower receptacles are provided with a 2" inside caulk drain and pop-out stainless steel grid strainer and are easy to install and maintain. Custom sizes and colors are available.



SBR-4832-3F
Shower Base Rectangular
(Shown with 3 sides Flanged and 1 side with an integral threshold)



SBC-36-2F
Shower Base Corner
(Shown with 2 sides Flanged and 3 sides with integral thresholds)



SBS-36-2F
Shower Base Square
(Shown with 2 sides Flanged and 2 sides with integral thresholds)

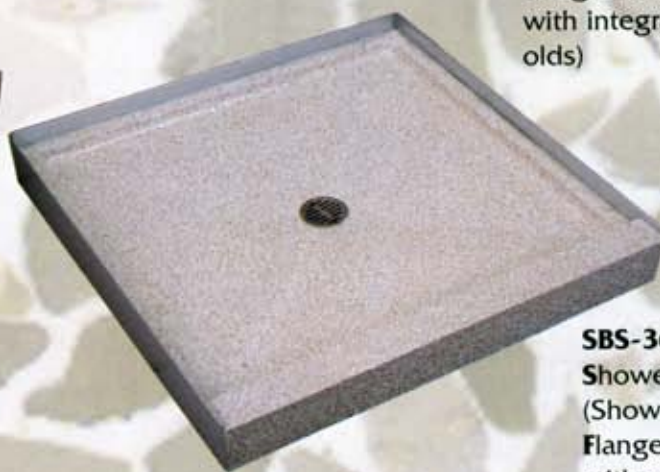

SBS-36-3F
Shower Base Square
(Shown with 3 sides Flanged and 1 side with an integral threshold)

ACCESSORIES



KDG2
Rubber Drain Gasket for
2" waste pipe

OPTIONS



-VRS
Vandal Resistant
Strainer



-OC
Optional Colors
(see page 2)

Integral Threshold Shower Bases

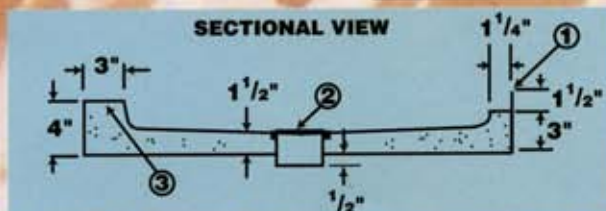
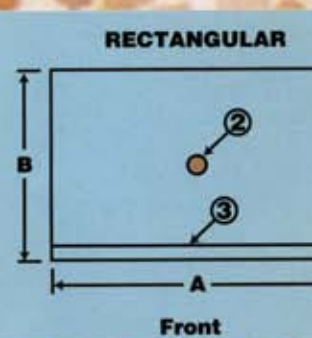
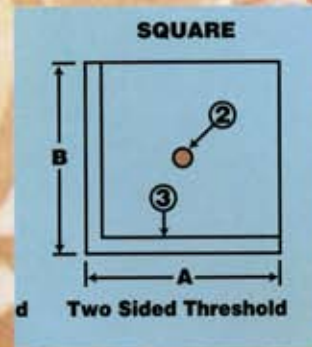
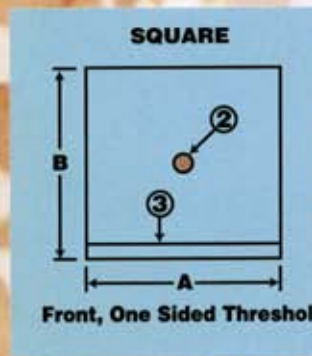
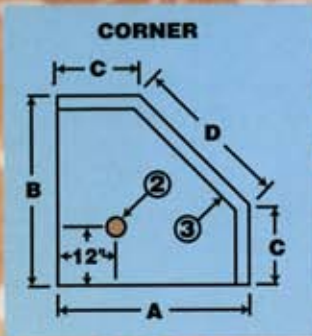

MODEL NUMBER	TYPE	THRESHOLD SIDES	FLANGED SIDES	SIZES / DIMENSIONS			
				A - LENGTH	B - WIDTH	C	D
SBC-32-2F	Corner	3	2	32" (813mm)	32" (813mm)	14" (356mm)	25 1/4" (648mm)
SBC-34-2F	Corner	3	2	34" (864mm)	34" (864mm)	17" (432mm)	24" (610mm)
SBC-36-2F	Corner	3	2	36" (914mm)	36" (914mm)	17" (432mm)	26 1/4" (683mm)
SBC-40-2F	Corner	3	2	40" (1016mm)	40" (1016mm)	20" (508mm)	28 1/4" (718mm)
SBS-30-3F	Square	1	3	30" (762mm)	30" (762mm)	-	-
SBS-32-3F	Square	1	3	32" (813mm)	32" (813mm)	-	-
SBS-34-3F	Square	1	3	34" (864mm)	34" (864mm)	-	-
SBS-36-3F	Square	1	3	36" (914mm)	36" (914mm)	-	-
SBS-40-3F	Square	1	3	40" (1016mm)	40" (1016mm)	-	-
SBS-42-3F	Square	1	3	42" (1067mm)	42" (1067mm)	-	-
SBS-48-3F	Square	1	3	48" (1219mm)	48" (1219mm)	-	-
SBS-32-2F	Square	2	2	32" (813mm)	32" (813mm)	-	-
SBS-36-2F	Square	2	2	36" (914mm)	36" (914mm)	-	-
SBS-40-2F	Square	2	2	40" (1016mm)	40" (1016mm)	-	-
SBR-3632-3F	Rectangular	1	3	36" (914mm)	32" (813mm)	-	-
SBR-4232-3F	Rectangular	1	3	42" (1067mm)	32" (813mm)	-	-
SBR-4234-3F	Rectangular	1	3	42" (1067mm)	34" (864mm)	-	-
SBR-4236-3F	Rectangular	1	3	42" (1067mm)	36" (914mm)	-	-
SBR-4832-3F	Rectangular	1	3	48" (1219mm)	32" (813mm)	-	-
SBR-4834-3F	Rectangular	1	3	48" (1219mm)	34" (864mm)	-	-
SBR-4836-3F	Rectangular	1	3	48" (1219mm)	36" (914mm)	-	-
SBR-5432-3F	Rectangular	1	3	54" (1372mm)	32" (813mm)	-	-
SBR-6032-3F	Rectangular	1	3	60" (1524mm)	32" (813mm)	-	-
SBR-6034-3F	Rectangular	1	3	60" (1524mm)	34" (864mm)	-	-
SBR-6036-3F	Rectangular	1	3	60" (1524mm)	36" (914mm)	-	-
SBR-3236-3F	Rectangular	1	3	32" (813mm)	36" (914mm)	-	-
SBR-3642-3F	Rectangular	1	3	36" (914mm)	42" (1067mm)	-	-

NOTES:

- ① Flange(s)
- ② Drain, 2" IC (Inside Caulk Outlet), centered within square & rectangular fixtures
- ③ Threshold

All Terrazzo Mop Sinks and Shower Bases must be installed with 1/4" clearance between mop sink or shower base and building wall and set in a layer of mortar between base and building floor to ensure that the mop sink or shower base can be leveled. Dimensions are subject to manufacturer's tolerance of plus or minus 1/4" and may change without notice. Acorn Engineering Co. assumes no responsibility for use of void or superseded data.

TERRAZZO-WARE SHOWER BASES

Fully Flanged Series

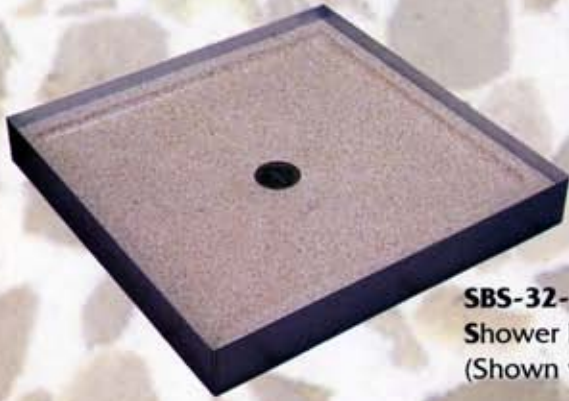

SBS-32-FF
Shower Base Square
(Shown with Fully Flanged sides)



SBC-36-FF
Shower Base Corner
(Shown with Fully Flanged sides)

Fully Flanged on all sides, including the entrance (-FF), distinguishes this line of Shower Bases. Offered in Square (SBS), Corner (SBC) or Rectangular (SBR) configurations, the fully flanged design allows for construction of a tiled entrance and tiled walls. Shower receptacles feature a 2" inside caulk drain and a pop-out stainless steel grid strainer. Custom sizes and colors are available.

Back Outlet Series



SBS-36-BO-FF
Shower Base Square, Back Outlet
(Shown with Fully Flanged sides)

Back Outlet (-BO) Shower Bases offered in the Square (SBS) configuration are the perfect solution to rear drainage installations. Drain has a removable stainless steel strainer and a 2" NPT female connection. Back Outlet shower bases are offered as fully flanged (-FF) or with an integral threshold (-3F). Custom sizes and colors are available.

OPTIONS

-VRS
Vandal Resistant Strainer



-OC
Optional Colors
(see page 2)



Shower Bases Fully Flanged

MODEL NUMBER	TYPE	SIZES / DIMENSIONS			
		A - LENGTH	B - WIDTH	C	D
SBS-32-FF	Square	32" (813mm)	32" (813mm)	-	-
SBS-36-FF	Square	36" (914mm)	36" (914mm)	-	-
SBS-40-FF	Square	40" (1016mm)	40" (1016mm)	-	-
SBC-36-FF	Corner	36" (914mm)	36" (914mm)	17" (432mm)	26 1/4" (683mm)
SBC-40-FF	Corner	40" (1016mm)	40" (1016mm)	20" (508mm)	28 1/4" (718mm)
SBR-4832-FF	Rectangular	48" (1219mm)	32" (813mm)	-	-

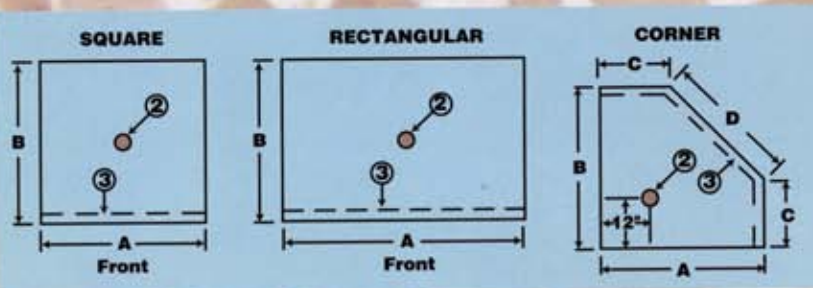

NOTES:

- ① Flange(s)
- ② Drain, 2" IC (Inside Caulk Outlet), centered within square & rectangular fixtures.
- ③ Entrance

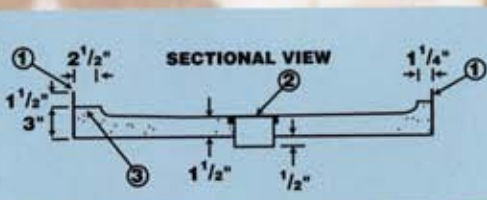

ACCESSORIES



KDG2
Rubber Drain Gasket
for 2" waste pipe

OPTIONS



-VRS
Vandal Resistant
Strainer

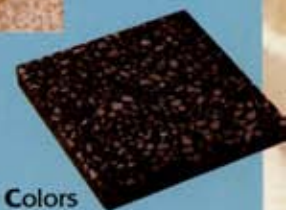

-OC
Optional Colors
(see page 2)

Shower Bases Back Outlet

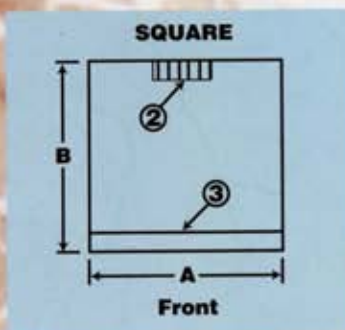

MODEL NUMBER	TYPE	THRESHOLD SIDES	FLANGED SIDES	SIZES / DIMENSIONS	
				A - LENGTH	B - WIDTH
SBS-36-80-FF	Square Fully Flanged	0	4	36" (914mm)	36" (914mm)
SBS-32-80-3F	Square Integral Threshold	1	3	32" (813mm)	32" (813mm)
SBS-36-80-3F	Square Integral Threshold	1	3	36" (914mm)	36" (914mm)

NOTES:

- ① Flange(s)
- ② Drain, 2" female NPT, centered on rear dimension.
- ③ Threshold or entrance

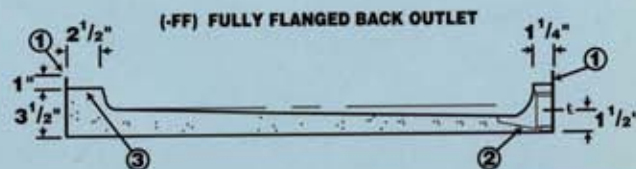
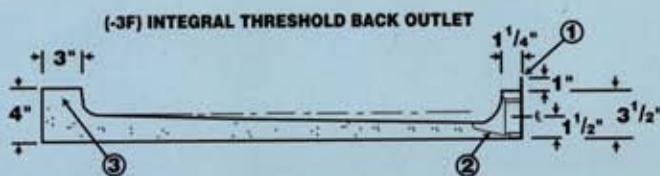

All Terrazzo Mop Sinks and Shower Bases must be installed with 1/4" clearance between mop sink or shower base and building wall and set in a layer of mortar between base and building floor to ensure that the mop sink or shower base can be leveled. Dimensions are subject to manufacturer's tolerance of plus or minus 1/4" and may change without notice. Acorn Engineering Co. assumes no responsibility for use of void or superseded data.

TERRAZZO-WARE SHOWER BASES

Institutional Series

Shower Bases in the Institutional Series are available in Corner (SBIC), Square (SBIS) and Rectangular (SBIR) configurations. These attractive and durable receptacles feature 6" high by 3" wide shoulders which display Terrazzo's natural beauty. The inside caulked drain comes with a pop-out stainless steel grid strainer which connects to a 2" pipe. Tiling flanges or 1" rabbets for tiled or marble walls are available options. Also available is a double receptacle within a single fixture where each receptacle of this twin unit has its own drain (specify -DD option). Custom colors and sizes are available.



SBIC-36
Shower Base Institutional Corner



SBIS-36
Shower Base Institutional Square



SBIS-36-RAB
Shower Base Institutional Square
(Shown with Rabbeted shoulders)



Shower Bases Institutional

MODEL NUMBER	TYPE	SIZES / DIMENSIONS			
		A - LENGTH	B - WIDTH	C	D
SBIC-36	Corner	36" (914mm)	36" (914mm)	17" (432mm)	26 1/2" (683mm)
SBIS-36	Square	36" (914mm)	36" (914mm)	-	-
SBIR-7236	Rectangular	72" (1829mm)	36" (914mm)	-	-

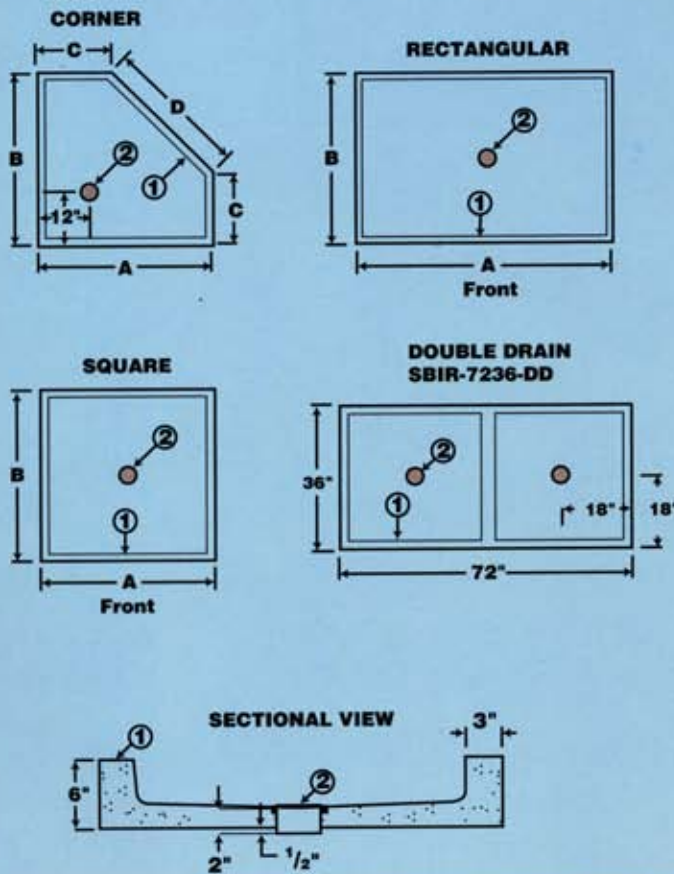

NOTES:

- ① Threshold or entrance
- ② Drain, 2" IC (Inside Caulk Outlet), centered within square & rectangular fixtures. Option -BO, Back Outlet drain 2" NPT, centered on rear dimension.

OPTIONS



-BO
Back Outlet (on SBIS-36 only, contact factory)



-DD
Double Drain (on SBIR-7236 only)



-F
Flanges, factory installed (contact factory)



-OC
Optional Colors (see page 2)



-RAB
Rabbeted shoulders (contact factory)



-VRS
Vandal Resistant Strainer

ACCESSORIES



KDG2
Rubber Drain Gasket for 2" waste pipe

TERRAZZO-WARE SHOWER BASES

Wheelchair Accessible Series

Shower Bases that are Wheelchair Accessible (SBWA) offer an attractive alternative for the physically challenged. The stainless steel ramp provides easy access while keeping water inside the shower receptacle. Shower bases feature a pop-out stainless steel grid strainer with a 2" inside caulk waste pipe connection. A floor drain near the shower entrance is recommended. Flanges on three sides (-3F) of the receptacle allow for tiled or marble wall applications. Custom sizes and colors are also available.



SBWA-6048-3F
Shower Base Wheelchair Accessible
(Shown with 3 sides Flanged)

ADA Series



Shower Bases designed for ADA compliant installations (SBADA) provide shower stall flooring as specified in the Americans With Disabilities Act (check your local codes). Shower bases feature a pop-out, stainless steel grid strainer with a 2" inside caulk waste pipe connection. Flanges on three sides (-3F) of the base allow wall tile to be applied by others to meet ADA required shower stall dimensions. A floor drain near the shower entrance is recommended. Custom colors are available.



SBADA-39-3F
Shower Base ADA
(Shown with 3 sides Flanged)



Shower Bases Wheelchair Accessible

MODEL NUMBER	TYPE	SIZES / DIMENSIONS			
		A - LENGTH	B - WIDTH	C	D
SBWA-36-3F	Square	36" (914mm)	36" (914mm)	18" (457mm)	12" (305mm)
SBWA-48-3F	Square	48" (1219mm)	48" (1219mm)	24" (610mm)	18" (457mm)
SBWA-60-3F	Square	60" (1524mm)	60" (1524mm)	30" (762mm)	24" (610mm)
SBWA-6048-3F	Rectangular	60" (1524mm)	48" (1219mm)	30" (762mm)	18" (457mm)
SBWA-4270-3F	Rectangular	42" (1067mm)	70" (1778mm)	21" (533mm)	9" (229mm)
SBWA-4870-3F	Rectangular	48" (1219mm)	70" (1778mm)	24" (610mm)	9" (229mm)
SBWA-6070-3F	Rectangular	60" (1524mm)	70" (1778mm)	30" (762mm)	9" (229mm)

OPTIONS



-VRS
Vandal Resistant Strainer



-OC
Optional Colors
(see page 2)

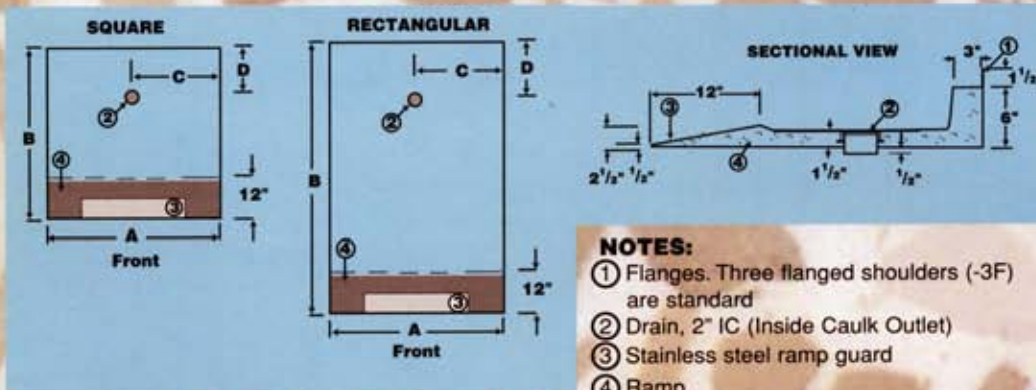

NOTES:

- ① Flanges. Three flanged shoulders (-3F) are standard
- ② Drain, 2" IC (Inside Caulk Outlet)
- ③ Stainless steel ramp guard
- ④ Ramp

ACCESSORIES



KDG2
Rubber Drain Gasket
for 2" waste pipe

Shower Bases ADA Series

MODEL NUMBER	TYPE	SIZES / DIMENSIONS					
		A - LENGTH	B - WIDTH	C	D	E	F
SBADA-39-3F	Square	39" (991mm)	39" (991mm)	19 1/2" (495mm)	12" (305mm)	36" (914mm)	37 1/2" (953mm)
SBADA-6030-3F	Rectangular	60" (1524mm)	30" (762mm)	30" (762mm)	12" (305mm)	57" (1448mm)	28 1/2" (724mm)

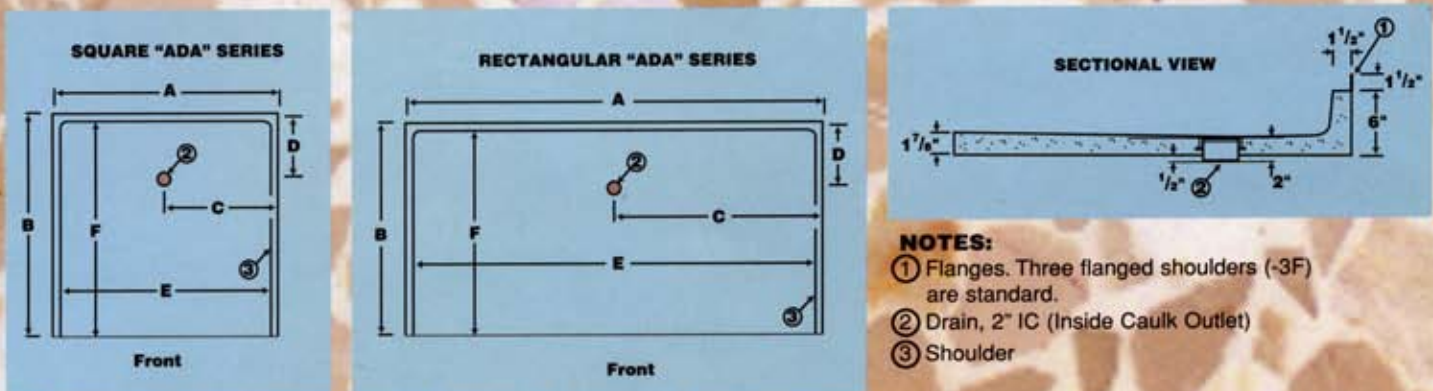

NOTES:

- ① Flanges. Three flanged shoulders (-3F) are standard.
- ② Drain, 2" IC (Inside Caulk Outlet)
- ③ Shoulder

All Terrazzo Mop Sinks and Shower Bases must be installed with 1/4" clearance between mop sink or shower base and building wall and set in a layer of mortar between base and building floor to ensure that the mop sink or shower base can be leveled. Dimensions are subject to manufacturer's tolerance of plus or minus 1/4" and may change without notice. Acorn Engineering Co. assumes no responsibility for use of void or superseded data.

Acorn also manufactures a line of high quality
Terrazzo-Ware™ group washing systems.



ADA Compliant Four Station QUAD-LAV Washfountain



ACORN ENGINEERING COMPANY
P.O. Box 3527 • City of Industry, California 91744-0527 U.S.A.
(800) 488-8999 • (818) 336-4561 • Fax (818) 961-2200