

Aqua-Pure®



Price Book and Product Selection Guide

Effective: January 1, 2014



3M Story

3M captures the spark of new ideas and transforms them into thousands of ingenious products. We're a leader in scores of markets – from health care and highway safety to office products and abrasives and adhesives.

Our success begins with our culture of creative collaboration that inspires a never-ending stream of powerful technologies and product solutions that make life better. We have an ability to apply our technologies – often in combination – to an endless array of real-world customer needs. Of course, all of this is made possible by the people of 3M, and their singular commitment to make life easier and better for people around the world.

3M Company also has hundreds of solutions to help customers reduce energy, air pollution, and waste, use more renewable resources, achieve green building certification, and protect employee health & safety.

3M's long standing commitment to sustainable development through environmental protection, social responsibility and economic progress has resulted in some of the following achievements:

- 2005 U.S. EPA Climate Protection Award
- 2006 U.S. EPA Clean Air Excellence Award
- 2005–2011 Energy Star Sustained Excellence Award for eight consecutive years
- 2009 member of the United States Green Build Council (USGBC)
- 2011 Interbrand ranked 3M #2 on its list of 2011 Best Global Green brands
 - 95% reduction in organic volatile air emissions (1990 - 2011)
 - 40% reduction in water used indexed to net sales (2005 - 2011)
 - 72% reduction in absolute greenhouse gas emissions (1990 - 2010)
 - 68% reduction in waste indexed to net sales (1990 - 2011)
 - 59% reduction in energy efficiency (2000 - 2011)
- 2013: 3M Purification first to achieve WQA Sustainability Certifications under the new WQA Product Sustainability standards:
 - WQA S-801 is a Sustainable Management standard that examines corporate governance actors including: social responsibility; environmental policies, goals and communications; as well as supplier sustainability performance.
 - WQA S-803, is a Product Sustainability standard for Activated Carbon Water Filtration Systems which encompasses cradle-to-grave attributes of a product, including raw material sourcing, manufacturing and assembly, packaging and end-of-life management.

3M is committed to providing innovative, cost-effective products that help protect people, equipment and our environment.

Aqua-Pure®

Why Do Wholesalers and Plumbers Choose 3M Aqua-Pure® Brand?

Aqua-Pure® branded water and filtration/treatment products have been the choice of plumbing professionals for over 50 years. Aqua-Pure products offer a wide range of solutions designed to address many types of water quality concerns. Third party certifications are an advantage provided on many Aqua-Pure water quality improvement solutions. 3M, a household brand name is a known leader in filtration technology recognized for innovation, trust and quality around the world.



Drinking Water Filtration Systems-Under Sink



Whole House Filtration



Water Treatment













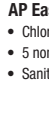

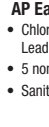























Table of Contents







| Section Description | Page |
|--|-------|
| Aqua-Pure® System Product Selection Guide | 3 |
| Drinking Water Filtration Systems | 5-7 |
| • Drinking Water Filtration System - Full Flow Solutions..... | 5-6 |
| • Drinking Water Filtration System - with Dedicated Faucet..... | 6-7 |
| • In-line Refrigerator/Ice Maker Filtration..... | 7 |
| • Drinking Water Filtration Replacement Cartridges..... | 8 |
| • Competitive Replacement Cartridges..... | 8 |
| • Replacement Cartridges For Discontinued Systems..... | 9-10 |
| • Drinking Water Filtration System Accessories..... | 11 |
| Whole House Filtration Systems - Sanitary Quick Change - (SQC) | 13 |
| • Aqua-Pure 900 Series Replacement Cartridges..... | 13 |
| • Accessories..... | 13 |
| Whole House Filtration Systems - Drop-in Sump Style | 14 |
| • Standard Diameter Housing Plastic Housing Filtration Systems..... | 14 |
| • Standard Diameter Housing Replacement Cartridges..... | 14 |
| • Accessories..... | 14 |
| • Large Diameter Plastic Housing Filtration Systems - Heavy Duty Performance..... | 15 |
| • Large Diameter Housing 800 Series Replacement Cartridges..... | 15 |
| • Accessories..... | 15 |
| • Standard Diameter Stainless Steel Housing Filtration Systems..... | 16 |
| • Standard Diameter Stainless Steel Housing Filtration Replacement Cartridges..... | 16 |
| • Large Diameter Stainless Steel Housing Filtration Systems..... | 17 |
| • Large Diameter Stainless Steel Filtration Replacement Cartridges..... | 17 |
| Scale Inhibition System | 18 |
| Standard Diameter Whole House Replacement Cartridges | 19 |
| • Progressive Porosity – Media Block Particulate Cartridges..... | 19 |
| • Ultra Fine & Extra-Fine Particulate Replacement Cartridges..... | 20 |
| Large Diameter Whole House Replacement Cartridges | 22 |
| • Large Diameter Replacement Cartridges For AP800 Series Systems..... | 22 |
| • Sanitary Quick Change - (SQC) AP900 Series Replacement Cartridges..... | 22 |
| Aqua-Pure Ultraviolet Light Systems | 23 |
| Water Softener Systems | 25-26 |
| Problem Water Systems | 27 |
| Backwash Filter Systems | 28 |
| Non-Backwash Carbon Filter Systems | 29 |
| Iron Reduction Systems | 30-31 |
| Acid Neutralizer Systems, Metering Pumps, Solution Tanks | 32 |
| Water Treatment Accessories, Water Test Kits | 33 |
| Media & Resin Selections | 34 |
| Replacement Parts | 37-44 |
| UV Pure® Ultraviolet Replacement Parts | 45-46 |
| Purwater Replacement Parts & Accessories | 47 |
| Aqua-Pure Sales Policies | 48-49 |
| Aqua-Pure Terms & Conditions | 49-50 |
| Lead Compliance Letter | 54 |



Product Selection Guide

Aqua-Pure water filtration and treatment products provide leading performance, many backed by third party certification. For more information on the entire portfolio please visit www.aquapure.com

| Under Sink Drinking Water Systems | | Whole House Water Filtration Systems | |
|--|--|--|---|
| Full Flow  3MFF100 <ul style="list-style-type: none"> Particulate, Cyst, Lead, Select VOC's* reduction 6,000 gallon capacity – 3X the capacity of our first generation products Flow rate 2.5 gpm <ul style="list-style-type: none"> Sanitary Quick Change (SQC) .2 Nominal Micron Utilizes existing faucet Reduces  | | Large Capacity, Sanitary Quick Change (SQC)  AP902 Whole House System <ul style="list-style-type: none"> Particulate, Dirt, Rust reduction Tested for up to 100,000 gallons of chlorine life High Flow rates up to 20 gpm Sanitary Quick Change (SQC) <ul style="list-style-type: none"> Manufactured for FDA CFR-21 compliant materials 5 micron nominal Reduces  | |
|  AP Easy Cyst-FF and AP Easy CS-FF <ul style="list-style-type: none"> Particulate, Chlorine Taste & Odor, Cyst** reduction (**Cyst-FF only) 2000 gallon capacity 2 gpm flow rate Sanitary Quick Change (SQC) <ul style="list-style-type: none"> Built-in shut off valve Installation Kit Included Reduces  | |  AP903 Whole House System <ul style="list-style-type: none"> Particulate, Dirt, Rust, Chlorine Taste & Odor reduction Tested for up to 100,000 gallons of chlorine life High Flow rates up to 20 gpm Sanitary Quick Change (SQC) <ul style="list-style-type: none"> Manufactured for FDA CFR-21 compliant materials 5 micron nominal Reduces  | |
| Dedicated Faucet  AP Easy Complete <ul style="list-style-type: none"> Chlorine Taste & Odor, Cyst, Lead, Mercury, Turbidity, Select VOC's* reduction 5 nominal micron rating Sanitary Quick Change (SQC) Reduces  | |  AP Easy CS-S <ul style="list-style-type: none"> Chlorine Taste & Odor reduction 5 nominal micron rating Sanitary Quick Change (SQC) Reduces  |  AP Easy LC <ul style="list-style-type: none"> Chlorine Taste & Odor, Cyst, Lead reduction 5 nominal micron rating Sanitary Quick Change (SQC) Reduces  |
|  AP-R05500 <ul style="list-style-type: none"> Chlorine Taste & Odor, Cyst, Lead, Select VOC's*, MTBE reduction 625 gallon capacity .6 gpm flow rate Sanitary Quick Change (SQC) <ul style="list-style-type: none"> Advanced dual stage carbon block filtration system Built-in automatic shut off meter Installation kit included Reduces  | |  AP904 Whole House System <ul style="list-style-type: none"> Particulate, Dirt, Rust, Chlorine Taste & Odor, Scale reduction Tested for up to 100,000 gallons of chlorine life High Flow rates up to 20 gpm Sanitary Quick Change (SQC) Reduces  | |
| Reverse Osmosis  AP-R05500 <ul style="list-style-type: none"> Arsenic, Cyst, TDS, Cadmium, Lead, Chromium, Turbidity reduction 25 gpd production rate Sanitary Quick Change (SQC) <ul style="list-style-type: none"> Advanced four stage filtration process Automatic shut-off Installation kit included Reduces  | | Standard Capacity/Large Capacity Sump Style Housings  AP801 with AP810 cartridge <ul style="list-style-type: none"> Particulate, Rust reduction 20 gpm flow rate Manufactured from FDA CFR-21 compliant materials Pressure Relief Button <ul style="list-style-type: none"> Selection of replacement cartridges for custom filter application Valve in Head 5 nominal micron rating Reduces  | |
| In-line Filters for Refrigerators/Ice Makers  AP717 <ul style="list-style-type: none"> Particulate, Rust, Chlorine Taste & Odor and Scale reduction 1,500 gallons filter life Premium performance progressive porosity <ul style="list-style-type: none"> 125 psi pressure rated design Packed with plumbing fittings and installation hardware 5 micron nominal Reduces  | |  AP101T with AP110 Cartridge <ul style="list-style-type: none"> Particulate, Rust reduction 8 gpm flow rate Blue Head Transparent Sump <ul style="list-style-type: none"> Piston Seal allows for variance in cartridge length Valve in Head 5 nominal micron rating Reduces  | |
|  IL-IM-01 <ul style="list-style-type: none"> Particulate, Rust, Chlorine taste & odor and Scale reduction 2,500 gallons filter life Premium performance progressive porosity 125 psi pressure rated design Packed with plumbing fittings and installation hardware .5 gpm flow rate Reduces  | |  SS4 EPE-316L with APS117 <ul style="list-style-type: none"> Particulate, Chlorine Taste and Odor and Scale inhibitor reduction 3 gpm flow rate Scale inhibitor Wetted welded surfaces are durable 316L Stainless Steel 5 nominal micron rating Reduces  | |
| Scale Inhibition  AP430SS with AP431 Cartridge <ul style="list-style-type: none"> Scale inhibitor 10 gpm flow rate Helps to protect hot water Heaters from corrosion Easy to install and change out cartridge Stainless steel head Reduces  | | | |
| Water Treatment | | | |
| Water Softeners  CWS100ME <ul style="list-style-type: none"> Helps to reduce dissolved "rock hard minerals" from your water Quick and easy installation Smart electronics to monitor water consumption automatically Reduces  | | Problem Water Systems  APIF150DM <ul style="list-style-type: none"> Reduces Iron No chemicals, chlorine, salt or potassium permanganate needed New dome hole for easier media replacement Reduces  | |

| Problem | Symptoms |
|--|--|
|  Particulate | Cloudy or discolored water, clogged faucet aerators, leaking valves and faucets |
|  Chlorine, Taste and Odor | Unpleasant organic taste, chlorine smell, musty smell |
|  Iron | Metallic taste in beverages and food, red, brown or rusty stains on clothing and/or plumbing fixtures |
|  Chemicals and Lead | Water contamination from agricultural and/or industrial chemicals potential lead based plumbing systems |
|  Hard Water | Soap deposits on dishes and clothing, soap curds in bathtub, scale in water heaters, clothes appear grey and unclean |
|  Scale | White/grey mineral deposits, build-up in hot water pipes, decreased water heater life |

*Select VOC's Benzene, Toxaphene and Dichlorobenzene

Drinking Water Filtration Systems - Under Sink

The Challenge:

Better tasting water at home, saving money spent on bottled water and, not having the hassle of lugging the bottles home, and protecting the environment from additional water bottle waste in land fills.

The Solution:

When a whole house system is not warranted, under sink systems can deliver great tasting water right from the faucet - saving both time and money. A large selection of systems and cartridges are available to provide a range of contaminant reduction for a home owner's individual needs.

Full Flow Solutions*

- Reduces range of contaminants including Particulate, Chlorine Taste & Odor, Cysts, Lead and Select VOCs
- Particulate filtration down to 0.2 Nominal Micron Rating
- Up to 6,000 gallon capacity
- Uses existing faucet for full flow
- Tested Flow Rate up to 2.5 gpm
- Quick and easy to install – under sink, out of sight
- Sanitary Quick Change (SQC) for quick and easy cartridge replacement



Dedicated Faucet Solutions*

- Reduces range of contaminants including Particulate, Chlorine Taste and Odor, Cyst, Lead, Mercury, Turbidity and select VOCs
- Particulate filtration down to 0.5 Nominal Micron Rating
- Uses Dedicated Faucet
- Sanitary Quick Change (SQC) for quick and easy cartridge replacement
- Built-in shut off valve



*see www.aquapure.com for specific product performance claims

Drinking Water Filtration Systems - Full Flow Solutions

Benefits of Aqua-Pure® Filtration:

A broad portfolio of Filtration Systems and replacement cartridges are available to provide custom solutions that homeowners demand – from basic water quality improvements to sophisticated contaminant claims.

Public or private well supply, Aqua-Pure branded products help provide you with cleaner, clearer, better tasting water!

3MFF100 Full Flow Drinking Water System

Features:

- Certified by the Water Quality Association to WQA S-803 for Product Sustainability attributes
- Newest member of the Aqua-Pure filtration family
- Advanced drinking water system has a 6,000 gallon capacity – three times the capacity of first generation products
- Significantly reduces particulate, chlorine taste & odor, cysts and lead
- 0.2 Nominal Micron Rating for particulate reduction
- Tested flow rate of 2.5 gallons per minute.
- Minimal under sink space required. No need to drill holes in sink for a separate faucet that could affect kitchen décor
- Full flow filtration to your existing kitchen or bath faucet.
- Utilizing our Sanitary Quick Change (SQC) cartridge design for easy cartridge change-out with Built-in shut off valve – no need to turn off water.
- Max Temp 100°F/37.8°C - Max Pressure 125 psi/862 kPa



| Model Number | Part Number/ 3M ID | Case Lot | Pk | Cartridge Included | Description | Flow Rate (gpm/lpm) | Filter Capacity (gal/lit) | Reduction Claims | Case Weight (lbs/kg) | UPC Code | List Price |
|--------------|-------------------------|----------|----|--------------------|---|---------------------|---------------------------|---|----------------------|----------------|-------------|
| 3MFF100 | 5616318/ 70020249671 | 6 | ST | 3MFF101 | Full-Flow Undersink 0.2 µm nominal 3/8" NPT | 2.5/9.5 | 6,000/ 22,712 | Particulate, CTO, Lead, Cysts & Select VOCs | 9.5/4.3 | 00016145233111 | \$350.00 ea |
| 3MFF101 | 5613432/ 70020249663 | 6 | ST | N/A | Replacement Cartridge | 2.5/9.5 | 6,000/ 22,712 | Particulate, CTO, Lead, Cysts & Select VOCs | 5.9/2.7 | 00016145233104 | \$275.00 ea |

Select VOC's include: Benzene, Toxaphene & P-Dichlorobenzene

AP Easy Full Flow Drinking Water Systems

Features:

- Full flow filtration to your existing kitchen or bath faucet, utilizing our Sanitary Quick Change (SQC) cartridge design
- Built-in shut off valve – no need to turn off water for cartridge change
- Installation kit included



AP Easy Full Flow Drinking Water Filtration Systems



| Model Number | Part Number/ 3M ID | Case Lot | Pk | Cartridge Included | Description | Flow Rate (gpm/lpm) | Filter Capacity (gal/lit) | Reduction Claims | Case Weight (lbs/kg) | UPC Code | List Price |
|--------------|-------------------------|----------|----|--------------------|---|---------------------|---------------------------|--|----------------------|----------------|-------------|
| CS-FF | 5609222/ 70020109495 | 4 | ST | C-CS-FF | Full-Flow Undersink 5 µm nominal 3/8" Quick Connect | 2/7.6 | 2,000/ 7,571 | CTO/ 5 µm nominal Particulate | 9.5/4.3 | 00016145102554 | \$145.00 ea |
| Cyst-FF | 5609223/ 70020109503 | 4 | ST | C-Cyst-FF | Full-Flow Undersink 0.5 µm nominal 3/8" Quick Connect | 1.5/5.7 | 2,000/ 7,571 | CTO/Cyst/ 0.5 µm nominal Particulate | 11.1/5 | 00016145102561 | \$157.50 ea |
| C-CS-FF | 5610427/ 70020109511 | 4 | ST | N/A | Replacement Cartridge | 2/7.6 | 2,000/ 7,571 | CTO/ 5 µm nominal Particulate | 5.9/2.7 | 00016145607592 | \$70.00 ea |
| C-Cyst-FF | 5610428/ 70020109529 | 4 | ST | N/A | Replacement Cartridge | 1.5/5.7 | 2,000/ 7,571 | CTO/Cyst/ 0.5 µm nominal Particulate | 7.3/3.3 | 00016145607608 | \$82.50 ea |

ST = STANDARD PACK CTO = CHLORINE TASTE & ODOR µm = MICRON

AP510 Full Flow Drinking Water Filtration System

Features:

- Triple action filtration and treatment system
- Built-in automatic shut-off valve
- Easy to install and change-out cartridge



AP510 Drinking Water Filtration System



| Model Number | Part Number/ 3M ID | Case Lot | Pk | Cartridge Included | Description | Flow Rate (gpm/lpm) | Filter Capacity (gal/lit) | Reduction Claims | Case Weight (lbs/kg) | UPC Code | List Price |
|--------------|-------------------------|----------|----|--------------------|--|---------------------|---------------------------|---|----------------------|----------------|-------------|
| AP510 | 5592202/ 70020017615 | 4 | ST | AP517 | Full-Flow Undersink 3/8" NPT Vertical | 1.75/6.6 | 2,000/ 7,571 | CTO/ 5 µm nominal Particulate/ Scale Inhibitor | 10/4.5 | 00016145510007 | \$250.00 ea |
| AP517 | AP51701/ 70020041458 | 12 | ST | N/A | Replacement Cartridge | 1.75/6.6 | 2,000/ 7,571 | CTO/ 5 µm nominal Particulate/ Scale Inhibitor | 18/8.2 | 00016145517006 | \$110.00 ea |
| | AP51706/ 70020041466 | 24 | BK | N/A | Replacement Cartridge | 1.75/6.6 | 2,000/ 7,571 | CTO/ 5 µm nominal Particulate/ Scale Inhibitor | 38/17.2 | 00016145517013 | \$103.00 ea |

ST = STANDARD PACK µm = MICRON

AP200 Full Flow Drinking Water Filtration System

Features:

- Offers space-saving compact design with a premium performance dual action cartridge
- Easy to install and change-out cartridge
- Multi-stage filtration



AP200 Full Flow Drinking Water Filtration System



| Model Number | Part Number/ 3M ID | Case Lot | Pk | Cartridge Included | Description | Flow Rate (gpm/lpm) | Filter Capacity (gal/lt) | Reduction Claims | Case Weight (lbs/kg) | UPC Code | List Price |
|--------------|-------------------------|-----------|----|--------------------|------------------------------|---------------------|--------------------------|----------------------------------|----------------------|----------------|----------------|
| AP200 | 5528901/ 70020007418 | 4 | ST | AP217 | Full-Flow Undersink 3/8" NPT | 1.75/6.6 | 2,000/ 7,571 | CTO/ 5 µm nominal Particulate | 10/4.5 | 00016145002007 | \$193.32 ea |
| AP217 | 4629002/ 70020014273 | 12 2pk | ST | N/A | Replacement Cartridge | 1.75/6.6 | 2,000/ 7,571 | CTO/ 5 µm nominal Particulate | 19/8.6 | 00016145217005 | \$118.32 2pk |
| | 4629005/ 70020146240 | 36 | BK | N/A | Replacement Cartridge | 1.75/6.6 | 2,000/ 7,571 | | 25/11.3 | 00016145106576 | \$1,916.78 blk |

ST = STANDARD PACK BK = BULK PACK µm = MICRON

Drinking Water Filtration Systems - with Dedicated Faucet

AP-RO5500 Reverse Osmosis Filtration System

Features:

- Automatic shut-off
- Installation kit included (includes faucet)/APRO5500 LF does not have faucet
- Advanced four stage filtration process: 5 micron nominal Particulate/rust filtration, activated carbon filtration, reverse osmosis and final activated carbon polishing filtration



AP-RO5500 Reverse Osmosis Filtration System



AP-RO5500

| Model Number | Part Number/ 3M ID | Case Lot | Pk | Cartridge Included | Description | Daily Production Rate** (gpd/lpd) | Reduction Claims | Case Weight (lbs/kg) | UPC Code | List Price |
|---------------------------|-------------------------|----------|----|----------------------|------------------------------------|-----------------------------------|---|----------------------|----------------|--------------|
| AP-RO5500 | 5598201/ 70020007889 | 1 | ST | AP5527 & AP5500RM | Undersink – RO | 25/94.6 | Arsenic, cysts, TDS, cadmium, lead, chromium, turbidity | 27/12.2 | 00016145550010 | \$699.00 ea |
| AP-RO5500 LF ² | 5598203/ 70020017987 | 1 | ST | | Undersink – RO Faucet Not Included | 25/94.6 | | 17/7.7 | 00016145603792 | \$624.00 ea |
| AP5527 | 5598101/ 70020017946 | 6 | ST | N/A | Prefilter & Postfilter | N/A | chlorine reduction | 18/8.2 | 00016145107450 | \$148.86 set |
| AP5500RM ² | 5608401/ 70020019231 | 1 | ST | N/A | RO Module | 25/94.6 | | 3/1.4 | 00016145008481 | \$200.00 ea |

** Daily production rate based on 250 ppm TDS, 50 psi, 77°F. Actual daily production rates can vary by up to 50%.

² Not NSF Listed ST = STANDARD PACK

ST = STANDARD PACK CTO = CHLORINE TASTE & ODOR µm = MICRON

Reverse Osmosis System Accessories

| Model Number | Part Number/ 3M ID | Description | UPC Code | List Price |
|--------------|--------------------------|---------------------------------------|----------------|------------|
| APRO-ST | 56-18125/ 70020170745 | 2.0 Gallon Polypropylene Storage-tank | 00016145165306 | \$47.57 ea |

AP-DWS1000 Drinking Water System

Features:

- Advanced dual stage carbon block filtration system
- Built-in automatic shut off meter
- SQC cartridge design
- Installation kit included (includes faucet)/AP-DWS1000 LF does not have faucet



2007 & 2010



AP-DWS1000 Drinking Water Filtration System



AP-DWS1000

| Model Number | Part Number/ 3M ID | Case Lot | Pk | Cartridge Included | Description | Flow Rate (gpm/lpm) | Filter Capacity (gal/lt) | Reduction Claims | Case Weight (lbs/kg) | UPC Code | List Price |
|----------------------------|-------------------------|----------|----|----------------------|--|---------------------|--------------------------|--------------------------------|----------------------|----------------|--------------|
| AP-DWS1000 | 5583101/ 70020007731 | 1 | ST | AP-DW80 & AP-DW90 | Undersink – DWS 1/4" Quick Connect | 0.6/2.3 | 625/ 2,366 | CTO/Lead/ Cyst/ VOC/MTBE | 10/4.5 | 00016145100017 | \$582.80 ea |
| AP-DWS1000 LF ² | 5583103/ 70020002427 | 1 | ST | | Undersink – DWS 1/4" Quick Connect Faucet Not Included | 0.6/2.3 | 625/ 2,366 | | 10/4.5 | 00016145603785 | \$522.80 ea |
| AP-DW80/90 | 5585102/ 70020002468 | 4 | ST | N/A | Replacement Cartridge | 0.6/2.3 | 625/ 2,366 | CTO/Lead/ Cyst/ VOC/MTBE | 20/9.1 | 00016145080906 | \$198.46 set |

² Not NSF Listed ST = STANDARD PACK

AP Easy Drinking Water Systems

Features:

- Under-sink single cartridge system, using our SQC cartridge design & a dedicated faucet
- Built-in shut off valve-no need to turn off water for cartridge change
- Installation kit included (includes faucet)



AP Easy Drinking Water Filtration Systems



Complete

| Model Number | Part Number/3M ID | Case Lot | Pk | Cartridge Included | Description | Flow Rate (gpm/lpm) | Filter Capacity (gal/lit) | Reduction Claims | Case Weight (lbs/kg) | UPC Code | List Price |
|-------------------|-------------------------|----------|----|--------------------|---|---------------------|---------------------------|---|----------------------|----------------|--------------------|
| CS-S | 5617905/ 70020109594 | 6 | ST | C-CS-S | Undersink — DWS 5 µm nominal 1/4" Quick Connect | 0.75/2.8 | 750/ 2,839 | CTO | 12.8/5.8 | 00016145102615 | \$200.00 ea |
| LC | 5617906/ 70020109602 | 6 | ST | C-LC | Undersink — DWS 0.5 µm nominal 1/4" Quick Connect | 0.75/2.8 | 750/ 2,839 | CTO/Lead/Cyst | 12.9/5.9 | 00016145102622 | \$225.00 ea |
| Complete | 5617904/ 70020109586 | 6 | ST | C-Complete | Undersink — DWS 0.5 µm nominal 1/4" Quick Connect | 0.75/2.8 | 750/ 2,839 | CTO/Lead/ Cyst/Mercury/ Turbidity/ VOCs ¹ | 14.3/6.5 | 00016145102608 | \$250.00 ea |
| C-CS-S | 5618009/ 70020109628 | 6 | ST | N/A | Replacement Cartridge | 0.75/2.8 | 750/ 2,839 | CTO | 5/2.3 | 00016145102646 | \$65.00 ea |
| C-LC | 5618011/ 70020109636 | 6 | ST | N/A | Replacement Cartridge | 0.75/2.8 | 750/ 2,839 | CTO/Lead/Cyst | 5.2/2.4 | 00016145066177 | \$90.00 ea |
| C-Complete | 5618007/ 70020109610 | 6 | ST | N/A | Replacement Cartridge | 0.75/2.8 | 750/ 2,839 | CTO/Lead/ Cyst/Mercury/ Turbidity/ VOCs ¹ | 6.2/2.8 | 00016145102639 | \$115.00 ea |

¹ Limited VOCs include: Lindane, Atrazine, Benzene, Carbofuran, P-dichlorobenzene and Toxaphene µm = MICRON
ST = STANDARD PACK CTO = CHLORINE TASTE & ODOR µm = MICRON

AP Easy Cooler Series (same as AP Easy Drinking Water Systems less faucet)



Complete Cooler

| Model Number | Part Number/3M ID | Case Lot | Pk | Cartridge Included | Description | Flow Rate (gpm/lpm) | Filter Capacity (gal/lit) | Reduction Claims | Case Weight (lbs/kg) | UPC Code | List Price |
|------------------------|-------------------------|----------|----|--------------------|---|---------------------|---------------------------|---|----------------------|----------------|--------------------|
| CS-S Cooler | 5617908/ 70020144096 | 6 | ST | C-CS-S | Undersink — DWS 5 µm nominal | 0.75/2.8 | 750/ 2,839 | CTO | 8.1/3.7 | 00016145140914 | \$140.00 ea |
| LC Cooler | 5617909/ 70020118843 | 6 | ST | C-LC | Undersink — DWS 0.5 µm nominal 1/4" Quick Connect | 0.75/2.8 | 750/ 2,839 | CTO/Lead/Cyst | 8/3.6 | 00016145115851 | \$165.00 ea |
| Complete Cooler | 5617907/ 70020144088 | 6 | ST | C-Complete | Undersink — DWS 0.5 µm nominal 1/4" Quick Connect | 0.75/2.8 | 750/ 2,839 | CTO/Lead/ Cyst/Mercury/ Turbidity/ VOCs ¹ | 9.4/4.3 | 00016145140907 | \$190.00 ea |

¹ Limited VOCs include: Lindane, Atrazine, Benzene, Carbofuran, P-dichlorobenzene and Toxaphene
ST = STANDARD PACK CTO = CHLORINE TASTE & ODOR µm = MICRON

In-Line Filtration for Refrigerators/Ice Makers

In-line Filtration for Refrigerators/Ice Makers



- Premium performance Progressive Porosity filtration
- Standard 1/4" NPT (AP717) and 1/4" push-in (IL-IM-01) inlet/outlet connections
- Manufactured with FDA CRF-21 compliant materials
- 125 psi pressure rated design
- 100°F (37.8°C) maximum operating temperature



Benefits of Aqua-Pure® Filtration:

Aqua-Pure makes a full line of refrigerator/icemaker filters to keep your ice tasting, smelling and looking fresh. Used in appliances with ice and water dispensers, Aqua-Pure filters helps reduce particulate, rust, chlorine taste and odor and scale. They can also be used for drinking fountains, coffee machines and drink dispensers.

Upgrade your appliance today and begin enjoying improved ice and water quality with the added benefit of reduced maintenance and service costs over the appliance's service life.

Refrigerator/Ice Maker Systems

| Model Number | Part Number/3M ID | Case Lot | Cartridge Included | Pk | Flow Rate (gpm/lpm) | Filter Life (gal./lit.) | Connect | Reduction Claims | Description | Case Weight (lbs/kg) | UPC Code | List Price |
|-----------------|-------------------------|----------|--------------------|----|---------------------|-------------------------|---------------------------|------------------|-------------|----------------------|----------------|-------------------|
| AP717 | 5551312/ 70020007509 | 12 | N/A | ST | 0.5/1.9 | 1,500/ 5,678 | 1/4" NPT x 1/4" Compr. | CTO/ Scale | In-line | 12/5.4 | 00016145717017 | \$46.34 ea |
| IL-IM-01 | 5617202/ 70020109560 | 10 | N/A | ST | 0.5/1.9 | 2,500/ 9,464 | 1/4" Push | CTO | In-line | 7.6/3.5 | 00016145066160 | \$32.62 ea |

CTO = CHLORINE TASTE & ODOR ST = STANDARD PACK

Drinking Water Filtration Replacement Cartridges



| Model Number | Part Number/ 3M ID | Case Lot | Pk | Cartridge Included | Description | Flow Rate (gpm/lpm) | Filter Capacity (gal/lt) | Reduction Claims | Case Weight (lbs/kg) | UPC Code | List Price |
|-----------------------|-------------------------|-----------|----|--------------------|------------------------|---------------------|--------------------------|---|----------------------|----------------|----------------|
| 3MFF101 | 5613432/ 70020249663 | 6 | ST | N/A | Replacement Cartridge | 2.5/9.5 | 6,000/ 22,712 | Particulate, CTO, Lead, Cysts & Select VOCs* | 5.9/2.7 | 00016145233104 | \$275.00 ea |
| AP217 | 4629002/ 70020014273 | 12 2pk | ST | N/A | Replacement Cartridge | 1.75/6.6 | 2,000/ 7,571 | CTO/ 5 µm nominal Particulate | 19/8.6 | 00016145217005 | \$118.32 2pk |
| | 4629005/ 70020146240 | 36 | BK | N/A | Replacement Cartridge | 1.75/6.6 | 2,000/ 7,571 | | 25/11.3 | 00016145106576 | \$1,916.78 blk |
| AP517 | AP51701/ 70020041458 | 12 | ST | N/A | Replacement Cartridge | 1.75/6.6 | 2,000/ 7,571 | CTO/ 5 µm nominal Particulate/ Scale Inhibitor | 18/8.2 | 00016145517006 | \$110.00 ea |
| | AP51706/ 70020041466 | 24 | BK | N/A | Replacement Cartridge | 1.75/6.6 | 2,000/ 7,571 | | 38/17.2 | 00016145517013 | \$103.00 ea |
| C-CS-FF | 5610427/ 70020109511 | 4 | ST | N/A | Replacement Cartridge | 2/7.6 | 2,000/ 7,571 | CTO/ 5 µm nominal Particulate | 5.9/2.7 | 00016145607592 | \$70.00 ea |
| C-Cyst-FF | 5610428/ 70020109529 | 4 | ST | N/A | Replacement Cartridge | 1.5/5.7 | 2,000/ 7,571 | CTO/Cyst/ 0.5 µm nominal Particulate | 7.3/3.3 | 00016145607608 | \$82.50 ea |
| C-CS-S | 5618009/ 70020109628 | 6 | ST | N/A | Replacement Cartridge | 0.75/2.8 | 750/ 2,839 | CTO | 5/2.3 | 00016145102646 | \$65.00 ea |
| C-LC | 5618011/ 70020109636 | 6 | ST | N/A | Replacement Cartridge | 0.75/2.8 | 750/ 2,839 | CTO/Lead/Cyst | 5.2/2.4 | 00016145066177 | \$90.00 ea |
| C-Complete | 5618007/ 70020109610 | 6 | ST | N/A | Replacement Cartridge | 0.75/2.8 | 750/ 2,839 | CTO/Lead/ Cyst/Mercury/ Turbidity/ VOCs ¹ | 6.2/2.8 | 00016145102639 | \$115.00 ea |
| AP-DW80/90 | 5585102/ 70020002468 | 4 | ST | N/A | Replacement Cartridge | 0.6/2.3 | 625/ 2,366 | CTO/Lead/ Cyst/ VOC/MTBE | 20/9.1 | 00016145080906 | \$198.46 set |
| AP5527 | 5598101/ 70020017946 | 6 | ST | N/A | Prefilter & Postfilter | N/A | | chlorine reduction | 18/8.2 | 00016145107450 | \$148.86 set |
| AP5500RM ² | 5608401/ 70020019231 | 1 | ST | N/A | RO Module | 25/94.6 | | | 3/1.4 | 00016145008481 | \$200.00 ea |

*Select VOC's include: Benzene, Toxaphene & P-Dichlorobenzene

ST = STANDARD PACK BK = BULK PACK µm = MICRON CTO = CHLORINE TASTE & ODOR

¹ Limited VOCs include: Lindane, Atrazine, Benzene, Carbofuran, P-dichlorobenzene and Toxaphene

² Not NSF Listed

Competitive Replacement Cartridges



| Model Number | Part Number/ 3M ID | Case Lot | Description | Pk | Maximum Temp (°F/°C) | Flow Rate (gpm/lpm) | Capacity gal/liter | Case Weight (lbs/kg) | UPC Code | List Price |
|------------------------------------|-------------------------|----------|--|----|----------------------|---------------------|--------------------|----------------------|----------------|-------------|
| EP15 Replacement | 5592402/ 70020017706 | 6 | CTO/Particulate Class 1/ Turbidity/Cyst | ST | 100/37.8 | 0.50/1.89 | 2,000/ 7,571 | 12/5.4 | 00016145604461 | \$115.82 ea |
| EP25 H-104/H-200 Replacement | 5592403/ 70020017714 | 6 | CTO/Particulate Class1/Lead/Cyst/ Select VOCs/ Asbestos/Mercury/ Chloramine | ST | 100/37.8 | 0.60/2.27 | 1,150/ 4,353 | 12/5.4 | 00016145604478 | \$156.19 ea |
| EP35R Replacement | 5592428/ 70020220797 | 6 | CTO/Particulate Class1/Lead/Cyst/ Select VOCs/ MTBE/TTHMs/ Asbestos/ Chloramine | ST | 100/37.8 | 0.50/1.89 | 350/ 1,325 | 12/5.4 | 00016145207082 | \$186.48 ea |

ST = STANDARD PACK

N.A. = Not available at time of document release.

PRICES SUBJECT TO CHANGE WITHOUT NOTICE

Replacement Cartridges For Discontinued Systems

| Model Number | Part Number/ 3M ID | Case Lot | Pk | Flow Rate (gpm/lpm) | Description | Case Wt. (lbs/kg) | UPC Code | List Price | |
|---------------------------|-------------------------|----------|--------|------------------------|----------------------------|---|----------|----------------|--------------------|
| AP300/AP305 | Discontinued | | SYSTEM | | Replaced by AP310 | | | | |
| AP317 | AP31703/ 70020041433 | 12 ea | | ST | 0.5/1.9 | 5 µm nominal Particulate & Rust/ Chlorine Taste & Odor/ Scale Inhibitor/ Replacement Cartridge | 12/5.4 | 00016145604850 | \$94.30 ea |
| | AP31701/ 70020041425 | 36 ea | | BK | 0.5/1.9 | 5 µm nominal Particulate & Rust/ Chlorine Taste & Odor/ Scale Inhibitor/ Replacement Cartridge | 27/12.2 | 00016145085383 | \$87.23 ea |
| µm = MICRON | | | | | | | | | |
| AP450 | Discontinued | | SYSTEM | | Replaced by AP310 | | | | |
| µm = MICRON | | | | | | | | | |
| AP26T | Discontinued | | SYSTEM | | | | | | |
| µm = MICRON | | | | | | | | | |
| AP500 | Discontinued | | SYSTEM | | Replaced by Model AP510 | | | | |
| AP517 | AP51701/ 70020041458 | 12 ea | | ST | 2/7.6 | 5 µm nominal Particulate & Rust/ Chlorine Taste & Odor/ Scale Inhibitor/ Replacement Cartridge | 18/8.2 | 00016145517006 | \$110.00 ea |
| | AP51706/ 70020041466 | 24 ea | | BK | 2/7.6 | 5 µm nominal Particulate & Rust/ Chlorine Taste & Odor/ Scale Inhibitor/ Replacement Cartridge | 38/17.2 | 00016145517013 | \$97.53 ea |
| µm = MICRON | | | | | | | | | |
| AP12T/AP12S/AP102S | Discontinued | | SYSTEM | | Replaced by AP102T | | | | |
| See Page 14 | | | | | Any 2.5" x 19.5" Cartridge | | | | |
| AP310 | Discontinued | | SYSTEM | | Replaced by IL-IM Series | | | | |
| AP327 | 5553622/ 70020007558 | 10 ea | | ST | 0.5/1.9 | Chlorine Taste Odor & Scale | 10/4.5 | 00016145327018 | \$51.14 ea |
| APIL3 | Discontinued | | SYSTEM | | Replaced by AP717 | | | | |
| APIL3R | 5605312/ 70020018738 | 10 ea | | ST | 0.5/1.9 | Particulate & Rust/ Chlorine Taste & Odor/Scale | | 00016145333118 | \$62.18 ea |

Replacement Cartridges For Discontinued Systems

| Model Number | Part Number/ 3M ID | Case Lot | Pk | Flow Rate (gpm/lpm) | Description | Case Wt. (lbs/kg) | UPC Code | List Price | |
|--------------|-------------------------|-----------|--------|------------------------|---------------------------------|---|----------|----------------|---------------------|
| AP-RO5000 | Discontinued | | SYSTEM | | Replaced by Model: AP-RO5500 | | | | |
| AP-RO5000 HF | Discontinued | | SYSTEM | | Replaced by Model: AP-RO5500 | | | | |
| AP110 | 5620404/ 70020162759 | 5 – 2 pk. | | NP | 8/30.3 | Particulate Prefilter | 13/5.9 | 00016145110009 | \$36.45 2pk |
| AP117RO | 5577801/ 70020015676 | 1 ea | | ST | 3/11.4 | Carbon Prefilter & Postfilter | 40/18.1 | 00016145073946 | \$41.41 ea |
| RM-TFC | Discontinued | | | | | | - | | |
| APRO3 | Discontinued | | SYSTEM | | Replaced by Model: AP-RO5500 | | | | |
| AP400SS | Discontinued | | SYSTEM | | | | | | |
| AP410 | 5527402/ 70020014366 | 2 pk. | | ST | 10/37.9 | Particulate/Rust/ Scale Inhibitor | 6/2.7 | 00016145410123 | \$103.22 2pk |
| AP-DWS700 | Discontinued | | SYSTEM | | Replaced by Complete | | | | |
| AP-DWS750 | Discontinued | | SYSTEM | | Replaced by LC | | | | |
| AP-DWS250 | Discontinued | | SYSTEM | | Replaced by CS-S | | | | |
| AP-DW85 | 5584408/ 70020002450 | 6 ea | | ST | | Lead/Cyst/Chlorine Taste & Odor | 6/2.7 | 00016145410123 | \$75.62 ea |
| AP-250R | 5598005/ 70020017938 | 1 ea | | ST | | Chlorine Taste & Odor | 8/3.6 | 00016145073526 | \$51.50 ea |
| AP-DW70 | 5584504/ 70020016500 | 1 ea | | ST | | Select VOC/MTBE/ Chlorine Taste & Odor | 12/5.4 | 00016145073533 | \$75.69 ea |

* Tested and verified by manufacturer's laboratory.

| | | | | | | | | |
|----------------|--------------|--|--------|--|----------------------------|--|--|--|
| AP11S | Discontinued | | SYSTEM | | Replaced by AP11T | | | |
| See page 14-15 | | | | | Any 2.5" x 9.75" Cartridge | | | |

AP51T

| | | | | | | | | | |
|-------|-------------------------|---------|------------|----|--------|---------------------------------|--------|----------------|--------------------|
| AP51T | Discontinued | | SYSTEM | | | | | | |
| AP117 | 5541705/ 70020107010 | 5 – 2pk | 3.0 x 9.75 | NP | 3/11.4 | Chlorine Taste Odor/Particulate | 13/5.9 | 00016145117008 | \$88.44 2pk |

Drinking Water Filtration System Accessories

Designer Drinking Water Faucets

The Point-of-Use decorative faucets come with an air-gap kit for use with reverse osmosis systems like the AP-RO5500. The long reach, full rotation, high reach 12" neck arches gracefully over the sink for ease of use. The base diameter is 2-1/4" (57mm) and all mounting hardware is included. The faucet comes with factory installed 36" length tubing for easy installation. The faucet is NSF Std. 61 listed.



| Model Number | Part Number/ 3M ID | Case Lot | Description | UPC Code | List Price |
|----------------|-------------------------|----------|---|----------------|--------------------|
| 6BG-CRM | 6221533/ 70020168913 | 1 | Air Gap, Non-Air Gap, Long Reach Faucet — Polished Chrome | 00016145163500 | \$225.05 ea |
| 6BG-STN | 6221534/ 70020168921 | 1 | Air Gap, Non-Air Gap, Long Reach Faucet — Satin Nickel | 00016145163517 | \$258.85 ea |
| 6BG-ATB | 6221535/ 70020168939 | 1 | Air Gap, Non-Air Gap, Long Reach Faucet — Antique Bronze | 00016145163524 | \$258.85 ea |
| 6BG-BTN | 6221536/ 70020168947 | 1 | Air Gap, Non-Air Gap, Long Reach Faucet — Bright Nickel | 00016145163531 | \$258.85 ea |
| 6BG-BSS | 6221537/ 70020168954 | 1 | Air Gap, Non-Air Gap, Long Reach Faucet — Brushed Stainless Steel | 00016145163548 | \$287.57 ea |

Standard Drinking Water Faucets



| Model Number | Part Number/ 3M ID | Case Lot | Description | UPC Code | List Price |
|-----------------|-------------------------|----------|---|----------------|-------------------|
| 62215-44 | 6221544/ 70020303833 | 1 | Stainless Steel Air Gap, Long Reach Faucet — Polished Chrome Finish | 00054007971658 | \$75.00 ea |
| 62215-45 | 6221545/ 70020238823 | 1 | Stainless Steel Non-Air Gap, Long Reach Faucet — Polished Chrome Finish | 00054007974925 | \$60.00 ea |

Drinking Water Filtration Systems Accessories

Reverse Osmosis System Accessories

| Model Number | Part Number/ 3M ID | Description | UPC Code | List Price |
|----------------|--------------------------|---------------------------------------|----------------|-------------------|
| APRO-ST | 56-18125/ 70020170745 | 2.0 Gallon Polypropylene Storage-tank | 00016145165306 | \$47.57 ea |

Tubing

| Model Number | Part Number/ 3M ID | Description | UPC Code | List Price |
|-----------------|--------------------------|------------------|----------------|------------------|
| 3/8 Blue | 82-11302/ 70020030121 | Blue 3/8" Tubing | 00016145016738 | \$0.84 ft |
| 1/4 Blue | 82-11202/ 70020030071 | Blue 1/4" Tubing | 00016145016684 | \$0.47 ft |

Point of Entry – Whole House

The Challenge:

Whole House Filtration that helps to reduce contaminants such as particulate, rust, precipitated scale, precipitated iron, minerals. Providing protection to all water using appliances and plumbing fixtures throughout the home

The Solution:

3M Aqua-Pure® Whole House Water Filtration Systems solutions include a full range of Quick Change Systems and Drop-in Sump Style Systems

Quick Change Systems*

- A range of contaminant reduction cartridges available for specific filtration needs including Particulate, Dirt, Rust, Scale and Chlorine Taste and Odor
- Tested up to 100,000 gallons chlorine reduction @ 10 gpm
- Peak Flow Rate – up to 20 gpm
- Sanitary Quick Change (SQC) for quick and easy cartridge replacement

Drop-in Style Systems*

- Filters reduce a range of contaminants including Particulate, Rust, Scale, Precipitated Iron
- Choose from several replacement cartridges for specific customer applications Capacity/Large Capacity, Plastic/Stainless Steel
- Many styles are available including Standard Capacity/Large Capacity, Plastic/Stainless Steel
- Manufactured from FDA CFR-21 compliant materials

*see www.aquapure.com for specific product performance claims



AP904



AP902



AP903



AP101T



AP801



AP1610SS



SS8
EPE-316L

Whole House Filtration Systems Sanitary Quick Change (SQC)



AP904

AP917HD-S

AP900 Series High Flow Filtration Systems

Benefits of Aqua-Pure High Flow Filtration Systems

Used at the point of entry, the AP900 Series High Flow Filtration System helps reduce particulate, rust, precipitated scale, precipitated iron/minerals from water using appliances and plumbing fixtures throughout the home or light commercial/industrial applications. Tested for up to 100,000 gallons of chlorine life* these cartridges require no wrench for cartridge change-out which are virtually spill-free.

- High flow rates up to 20 gpm for larger homes, light commercial/industrial applications
- For use with SQC style Particulate or CTO cartridge
- 304 SS Head with 1" NPT inlet/outlet connections
- Die cast zinc anti-rotation collar & locking latch
- Manufactured from FDA CFR-21 compliant materials



COMPONENT

AP910R, AP917HD,
AP917HD-S

| Model Number | Part Number/ 3M ID | Case Lot | Ctg. Incl. | Includes | Maximum Temp (°F/°C) | Maximum Pressure (psi/kPa) | Flow Rate (gpm/lpm) | Size (approx.) (in/cm) | Housing Material And Style* | Case Weight (lbs/kg) | UPC Code | Sugg. List |
|--------------|-------------------------|----------|----------------------|----------|----------------------|----------------------------|---|------------------------------|-----------------------------|----------------------|----------------|--------------------|
| AP902 | 5621101/ 70020204353 | 1 | AP910R 5621001 | MB | 100/37.8 | 125/862 | 20/75.7 | 25-1/16 x 4 (63.7 x 10.2) | SS Head, Blue Sump | 7/3.2 | 00016145191930 | \$393.48 ea |
| AP903 | 5621102/ 70020204361 | 1 | AP917HD 5621006 | MB | 100/37.8 | 125/862 | 20/75.7 | 25-1/16 x 4 (63.7 x 10.2) | SS Head, Blue Sump | 7.5/3.4 | 00016145191947 | \$468.49 ea |
| AP904 | 5621104/ 70020284975 | 1 | AP917HD-S 5621008 | MB | 100/37.8 | 125/862 | 20/75.7 | 25-1/16 x 4 (63.7 x 10.2) | SS Head, Blue Sump | 7.5/3.4 | 0001645266997 | \$532.45 ea |
| AP910R | 5621001/ 70020204460 | 1 | N/A | N/A | 100-37.8 | 125/862 | Incl. with AP902 Fine (5 µm nominal) Particulate/Dirt/Rust | | | 3.5/1.6 | 00016145192043 | \$204.32 ea |
| AP917HD | 5621006/ 70020269687 | 1 | N/A | N/A | 100/37.8 | 125/862 | Incl. with AP903, Fine (5 µm nominal) Particulate/Dirt/Rust up to 100,000 gallons Chlorine Taste and Odor | | | 3/1.4 | 00016145252303 | \$279.33 ea |
| AP917HD-S | 5621008/ 70020273929 | 1 | N/A | N/A | 100/37.8 | 125/862 | Incl. with AP904, Fine (5 µm nominal) Particulate/Dirt/Rust/Scale up to 100,000 gallons Chlorine Taste and Odor | | | 3/1.4 | 00016145256547 | \$343.29 ea |

MB = MOUNTING BRACKET INCLUDED

Accessories

| | | | | | | | | | | | | |
|---------|------------------------|---|--|--|--|--|--|--|--|-------|----------------|--------------------|
| 6223601 | 6223601 70020200922 | 1 | Mounting Kit for AP900 Series (Bracket, Screw, Locking Washer) | | | | | | | 1/0.5 | 00016145188725 | \$14.53 ea |
| 6223201 | 6223201 70020273937 | 1 | Head assembly | | | | | | | 4/1.8 | 00016145256523 | \$200.51 ea |

* AP910R, AP917HD & AP917HD-S only. Results may vary depending on water condition.

Whole House Filtration Systems - Drop-in Sump Style



Standard Diameter Plastic Housing Filtration Systems

- Standard 3/4" NPT connections
- For use with industry standard size cartridges: 2-1/2" to 3" O.D. x 9-3/4" (single)
- Piston seal allows for variance in cartridge length
- Manufactured from Food and Drug Administration (FDA) CFR-21 compliant materials

Model AP102T also:

- Accepts two integral length 9-3/4" length cartridges or one 19-1/2" length cartridge
- Includes center-post for proper cartridge alignment

Benefits of Aqua-Pure® Filtration Products:

Used at the point of entry, Aqua-Pure standard whole house filters reduce particulate, rust, chlorine taste and odor, and scale (from all water using appliances and plumbing fixtures throughout the home). Choose from several replacement cartridges for a custom filter application.

Two-High models expand filtration applications and capabilities above standard single-length housings:
Higher service flow rates, increased filtration efficiencies as well as specialty applications.

| Model Number | Part Number/ 3M ID | Case Lot | Ctg. Incl. | Includes | Maximum Temp (°F/°C) | Maximum Pressure (psi/kPa) | Flow Rate (gpm/lpm) | Size W x L (inches) | Description | Case Weight (lbs/kg) | UPC Code | List Price |
|--------------|-------------------------|----------|--------------|----------|----------------------|----------------------------|---------------------|---------------------|--|----------------------|----------------|--------------------|
| AP11T | 5529902/ 70020005834 | 4 | AP110 | W | 100/37.8 | 125/862 | 8/30.3 ¹ | 4-9/16 x 13-11/16 | Blue Head, Transparent Sump, Pressure Relief | 13/5.9 | 00016145001116 | \$158.17 ea |
| AP101T | 5530002/ 70020002278 | 4 | AP110 | W | 100/37.8 | 125/862 | 8/30.3 ¹ | 4-9/16 x 14-7/8 | Blue Head, Transparent Sump, Valve-In-Head | 13/5.9 | 00016145010118 | \$196.04 ea |
| AP141T | 5530016 70020166123 | 4 | AP420 | W | 100/37.8 | 125/862 | 10/37.9 | 4-9/16 x 14-3/16 | Blue Head, Transparent Sump, Valve-In-Head | 13/5.9 | 00016145160707 | \$259.26 ea |
| AP102T | 5530008/ 70020014422 | 2 | Not Included | W | 100/37.8 | 125/862 | N/A ¹ | 4-9/16 x 24-1/8 | Blue Head, Transparent Sump, Valve-In-Head | 10/4.5 | 00016145001024 | \$269.65 ea |

¹ Flow based on rated flow of cartridge used W = WRENCH INCLUDED

Replacement Cartridges – Most Common; Refer to replacement cartridge section for more options

| Model Number | Part Number/ 3M ID | Case Lot | Size Dia. x L | Pk | Flow Rate (gpm/lpm) | Nominal Micron Rating | Description | Case Weight (lbs/kg) | UPC Code | List Price |
|--------------|--------------------------|----------|---------------|----|---------------------|-----------------------|---|----------------------|----------------|-----------------------|
| AP110 | 5620404/ 70020162759 | 5 2pk | 2.5 x 9.75 | NP | 8/30.3 | 5 | Standard Particulate/Rust Progressive Porosity Melt Blown | 5/2.3 | 00016145157349 | \$36.45 2pk |
| | 5620406/ 70020162775 | 36 ea | 2.5 x 9.75 | BK | | | | 13/5.9 | 00016145157363 | \$16.66 ea |
| AP110-2 | 5620405/ 70020162767 | 15 ea | 2.5 x 19.5 | ST | 16/60.6 | 5 | 2-High, Standard Particulate/Rust Progressive Porosity Melt Blown | 12/5.4 | 00016145157356 | \$32.81 ea |
| AP124 | 5620601/ 70020162833 | 5 2pk | 2.5 x 9.75 | NP | 8/30.3 | 50 | Coarse Particulate/Rust Progressive Porosity Melt Blown | 5/2.3 | 00016145157424 | \$42.39 2pk |
| | 5620605/ 70020162874 | 36 ea | 2.5 x 9.75 | BK | | | | 13/5.9 | 00016145157462 | \$19.47 ea |
| AP117* | 5541705/ 70020107010 | 5 2pk | 3.0 x 9.75 | NP | 3/11.4 | 5 | Chlorine Taste & Odor Standard Particulate/Rust Melt Blown GAC | 13/5.9 | 00016145110450 | \$85.86 2pk |
| | 5541706/ 70020007467 | 10 2pk | 3.0 x 9.75 | WP | | | | 25/11.3 | 00016145106644 | \$85.86 2pk |
| | 5541714/ 70020146323 | 36 ea | 3.0 x 9.75 | BK | | | | 38/17.2 | 00016145006784 | \$1,429.33 blk |
| APS117* | APS11701/ 70020003086 | 24 ea | 3.0 x 9.75 | ST | 3/11.4 | 5 | Chlorine Taste & Odor Particulate, Scale Inhibitor | 28/12.7 | 00016145106514 | \$54.13 ea |
| AP420 | 5527407/ 70020002252 | 6 2pk | 2.94 x 9.75 | ST | 10/37.9 | 5 | Standard Particulate/Rust Scale Inhibitor | 16/7.3 | 00016145601095 | \$164.10 2pk |

BK = BULK PACK NP = NARROW PACK ST = STANDARD PACK WP = WIDE PACK

Accessories (Refer to parts section for more information)

| | | | | | | | | | |
|----------|---------------------------|---|--|--|--|--|-------|----------------|-------------------|
| AP-WRNCH | 6843432C/ 70020028430 | 1 | Sump wrench, AP11 & AP101 Series | | | | 1/0.5 | 00016145604621 | \$8.88 ea |
| COUPLER | 6899831/ 70020008051 | 1 | Cartridge Adapter: Connects (2) 9 3/4" cartridges to fit 20" competitive length housings | | | | 1/0.5 | 00016145002175 | \$2.15 ea |
| O-RING | 63597174C/ 70020008242 | 1 | Sump o-ring for AP11 & AP101 | | | | 1/0.5 | 00016145600388 | \$5.31 ea |
| AP-MB | 5551701/ 70020007525 | 1 | Mounting Bracket – Fits AP11, AP101, AP51, AP12 and AP102 | | | | 1/0.5 | 00016145604140 | \$12.95 ea |

* For whole house CTO reduction applications, 3M Purification recommends the use of an AP102T with (2) AP117 cartridges



Large Diameter Plastic Housing Filtration Systems-Heavy Duty Performance

- High flow rates up to 45 gpm for larger homes
- 1" inlet/outlet connection options
- Manufactured from FDA CFR-21 compliant materials
- Pressure Relief Button
- For use with industry standard size cartridges:
4-1/2" O.D. x 9-3/4" (single) and 20" (2-high)

Benefits of Aqua-Pure® Filtration Products:

For use at the point of entry, AP800 Series whole house filtration systems help reduce particulate, rust, scale, precipitated iron and minerals from all water using appliances and plumbing fixtures throughout the home. Choose from our selection of replacement cartridges for a custom filter application.

| Model Number | Part Number/ 3M ID | Case Lot | Ctg. Incl. | Includes | Maximum Temp (°F/°C) | Maximum Pressure (psi/kPa) | Flow Rate (gpm/lpm) | Size W x L (inches) | Housing Material And Style* | Case Weight (lbs/kg) | UPC Code | List Price |
|--------------|-------------------------|----------|--------------|----------|----------------------|----------------------------|---------------------|---------------------|-----------------------------|----------------------|----------------|--------------------|
| AP801 | 5585701/ 70020007822 | 2 | Not Included | W | 100/37.8 | 100/689 | N/A* | 7-1/4 x 13-5/16 | White Head, Blue Sump | 14/6.4 | 00016145607165 | \$152.89 ea |
| AP801-C | 5585716/ 70020114180 | 2 | AP810 | W MB | 100/37.8 | 100/689 | 20/75.7 | 7-1/4 x 13-5/16 | White Head, Blue Sump | 15/6.8 | 00016145605239 | \$187.53 ea |
| AP802 | 5585704/ 70020002492 | 2 | Not Included | W | 100/37.8 | 100/689 | N/A* | 7-1/4 x 23-7/16 | White Head, Blue Sump | 17/7.7 | 00016145802102 | \$204.63 ea |

W = WRENCH INCLUDED

MB = MOUNTING BRACKET INCLUDED

* flow rate is dependent upon cartridge use

AP800 Series Replacement Cartridges

| Model Number | Part Number/ 3M ID | Case Lot | Size Dia. x L (inches) | Pk | Flow Rate (gpm/lpm) | Nominal Micron Rating | Description | Case Weight (lbs/kg) | UPC Code | List Price |
|--------------|-------------------------|----------|------------------------|----|---------------------|-----------------------|--|----------------------|----------------|--------------------|
| AP810 | 5618902/ 70020164177 | 4 | 4.5 x 9.75 | NP | 20/75.7 | 5 | 1-High, Standard Particulate/Rust/Melt Blown | 5/2.3 | 00016145158766 | \$48.04 ea |
| AP810-2 | 5618903/ 70020162437 | 4 | 4.5 x 20 | ST | 45/170.3 | 5 | 2-High, Standard Particulate/Rust/Melt Blown | 11/5 | 00016145157028 | \$84.20 ea |
| AP811 | 5618904/ 70020170547 | 4 | 4.5 x 9.75 | ST | 20/75.7 | 25 | 1-High, Medium Particulate/Rust/Melt Blown | 5/2.3 | 00016145165108 | \$58.08 ea |
| AP811-2 | 5618905/ 70020176742 | 4 | 4.5 x 20 | ST | 45/170.3 | 25 | 2-High, Medium Particulate/Rust/Melt Blown | 11/5 | 00016145171277 | \$93.05 ea |
| AP814 | 5599401/ 70020105329 | 4 | 4.5 x 9.75 | ST | 20/75.7 | 50 | 1-High, Coarse Particulate/Rust Composite Wound | 7/3.2 | 00016145811418 | \$44.14 ea |
| AP814-2 | 5599403/ 70020105337 | 4 | 4.5 x 20 | ST | 45/170.3 | 50 | 2-High, Coarse Particulate/Rust Composite Wound | 16/7.3 | 00016145814204 | \$87.30 ea |
| AP817 | 5602701/ 70020169648 | 4 | 4.5 x 9.75 | ST | 10/37.9 | 25 | 1-High, Chlorine Taste Odor and Particulate, GAC | 7/3.2 | 00016145164200 | \$76.80 ea |
| AP817-2 | 5602707/ 70020169671 | 4 | 4.5 X 20 | ST | 20/75.7 | 25 | 2-High, Chlorine Taste Odor and Particulate, GAC | 25/11.3 | 00016145164231 | \$152.94 ea |

NP = NARROW PACK

ST = STANDARD PACK

Accessories

| | | | | | | | | | | |
|--------------|-------------------------|---|---|--|--|--|--|-------|----------------|-------------------|
| AP-MB801 | 6890131/ 70020021948 | 1 | Mounting Bracket for AP800 Series Housings | | | | | 1/0.5 | 00016145604720 | \$30.78 ea |
| O-RING | 6889832/ 70020021906 | 1 | Sump o-ring for AP800 Series Housings | | | | | 1/0.5 | 00016145002175 | \$3.42 ea |
| WRENCH | 6890033/ 70020021930 | 1 | Wrench for all AP800 Series Housings | | | | | 1/0.5 | 00016145607233 | \$10.53 ea |
| STRAP WRENCH | 6890034/ 70020109685 | 1 | Adjustable Strap Wrench for all AP800 Series Housings | | | | | 1/0.5 | 00016145606229 | \$14.06 ea |

Standard Diameter Stainless Steel Housing Filtration Systems



AP2610SS AP1610SS

- 316 stainless steel head and 304 stainless steel housing rated to 300 psi
- SST Housings rated for 200°F¹ (93.3°C) operating temperatures
- All stainless steel construction designed for use in filtration applications
- Made from Food and Drug Administration USA CFR-21 compliant materials
- Multiple connection sizes ranging from 3/8" NPT Vertical to 1" NPT Horizontal
- Hot and cold water applications
- For use with industry standard size cartridges:
 - 2-1/2", 2-3/4", 3" O.D. x 9-3/4" L (single)
 - 2-1/2", 2-3/4", 3" O.D. x 19-1/2" L (double)

Benefits of Aqua-Pure® Stainless Steel Filtration Products:

Stainless steel construction helps provide reliable performance demanded by remote installations. Ideal use in second homes and cottages, homes without basements, corrosive environments and where service and maintenance is restricted.

| Model Number | Part Number/ 3M ID | Case Lot | Ctg. Incl. | Includes | Maximum Temp ¹ (F/°C) | Maximum Pressure (psi/kPa) | Flow Rate ² (gpm/lpm) | Connection Size | Description | Case Weight (lbs/kg) | UPC Code | List Price |
|--------------|-------------------------|----------|-----------------|----------|-------------------------------------|-------------------------------|-------------------------------------|------------------------|--------------------------------------|-------------------------|----------------|-------------|
| AP1610SS | 5592002/ 70020017532 | 1 | AP110 | W MB | 170/77 | 125/862 | 8/30.3 | 3/4" NPT Horizontal | 316 SS Head 1-High 304 SS Housing | 20/9 | 00016145603020 | \$412.74 ea |
| AP2610SS | 5592003/ 70020114198 | 1 | AP110-2 | W MB | 170/77 | 125/862 | 16/60.6 | 3/4" NPT Horizontal | 316 SS Head 2-High 304 SS Housing | 50.4/ 22.9 | 00016145603235 | \$610.03 ea |
| SST1 | 5527104/ 70020014323 | 1 | Not Included | W MB | 200/93.3 | 300/2,068 | N/A* | 3/8" NPT Vertical | 316 SS Head 1-High 304 SS Housing | 22/10 | 00016145604072 | \$343.51 ea |
| SST1HA | 5592001/ 70020017524 | 1 | Not Included | W MB | 200/93.3 | 300/2,068 | N/A* | 3/4" NPT Horizontal | 316 SS Head 1-High 304 SS Housing | 22/10 | 00016145601248 | \$402.52 ea |
| SST2HB | 5592010/ 70020017573 | 1 | Not Included | W MB | 200/93.3 | 300/2,068 | N/A* | 1" NPT Horizontal | 316 SS Head 2-High 304 SS Housing | 55/24.9 | 00016145603037 | \$620.70 ea |

Fit For Use Replacement Cartridges — Most Common; Refer to replacement cartridge section for more options

| Model Number | Part Number/ 3M ID | Case Lot | Size Dia. x L | Pk | Flow Rate (gpm/lpm) | Nominal Micron Rating | Description | Case Weight (lbs/kg) | UPC Code | List Price |
|--------------|-------------------------|----------|------------------|----|------------------------|--------------------------|---|----------------------------|----------------|-------------|
| AP110 | 5620404/ 70020162759 | 5 2pk | 2.5 x 9.75 | NP | 8/30.3 | 5 | Standard Particulate/Rust Progressive Porosity | 5/2.3 | 00016145157349 | \$36.45 2pk |
| | 5620406/ 70020162775 | 36 ea | 2.5 x 9.75 | BK | | | Melt Blown | 13/5.9 | 00016145157363 | \$16.66 ea |
| AP110-2 | 5620405/ 70020162767 | 15 ea | 2.5 x 19.5 | ST | 16/60.6 | 5 | 2-High, Standard Particulate/Rust Progressive Porosity Melt Blown | 12/5.4 | 00016145157356 | \$32.81 ea |

BK = BULK PACK NP = NARROW PACK ST = STANDARD PACK WP = WIDE PACK

¹ Maximum operating temperature and pressure are dependent on filter cartridge

W = WRENCH INCLUDED

² Flow rates based on Particulate cartridge

MB = MOUNTING BRACKET INCLUDED

* Flow rate is dependent upon cartridge use

Note: Single high housings should not be used with an AP117 or APS117 for whole house applications due to low flow rates. Use two-high housings with (2) cartridges.

Note: For hot water applications, use AP110, AP2005, AP1001 or AP1003 cartridges. See page 15 for more information.



SS12 EPE-316L SS8 EPE-316L SS4 EPE-316L

Large Diameter Stainless Steel Housing Filtration Systems

- Construction: Wetted welded surfaces are durable 316L stainless steel.
- Shouldered seal plates fit solidly into the cartridge core for a positive seal.
- V-band clamp for quick and easy opening and closing.
- Removable cartridge posts lift out for easy cleaning.
- Housing Drains; Both sludge and clean chambers have drain couplings for easy cleaning.
- Air vent allows venting before start-up or draining.
- High temperature capacity (up to 250°F (121°C) dependent upon filter cartridge selected)
- Specially designed cartridge seal plates for 9-3/4" or 10" equivalent length cartridges

SS EPE Series: Electropolished 316L stainless steel for filtration, process, and food grade environments

Why Choose 316L Stainless Steel Fabrication?

Atmospheric corrosion accounts for more failures on both a tonnage basis and cost basis than any other type of environmental corrosion. Tremendous amounts of steel are exposed to the atmosphere and attacked by oxygen and water. The corrosion severity is increased when salt, sulfur compounds and other atmospheric contaminants are present. 3M Purification Inc. has intensely studied the effects of corrosion on stainless steel products and analyzed several stainless steel fabrication techniques. Based on destructive testing, 316L stainless steel fabrication yielded unequalled performance.

| Model Number | Part Number/ 3M ID | Case Lot | Cartridges Included | Maximum Temp. ¹ (°F/°C) | Maximum Pressure (psi/kPa) | Flow Rate ² (gpm/lpm) | Equiv. No. Single Lg Ctgs | Housing Specs | Case Weight (lbs/kg) | UPC Code | List Price |
|---------------|-------------------------|----------|---------------------|---------------------------------------|-------------------------------|-------------------------------------|------------------------------|--|-------------------------|----------------|----------------|
| SS4 EPE-316L | 4808713/ 70020205673 | 1 | Not Included | 250/121 | 150/1,034 | 32/121 | 4 | 316L SS Electropolished 1-1/2" NPT Male Inlet | 25/11.3 | 00016145193248 | \$2,840.56 ea |
| SS8 EPE-316L | 4808714/ 70020204775 | 1 | Not Included | 250/121 | 150/1,034 | 64/242 | 8 | 316L SS Electropolished 2" NPT Male Inlet | 30/13.6 | 00016145192357 | \$3,073.21 ea |
| SS12 EPE-316L | 4808715/ 70020205681 | 1 | Not Included | 250/121 | 150/1,034 | 96/363 | 12 | 316L SS Electropolished 2" NPT Male Inlet | 35/15.9 | 00016145193255 | \$3,311.28 ea |
| SS20 EPE-316L | 4808816/ 70020205905 | 1 | Not Included | 250/121 | 150/1,034 | 160/606 | 20 | 316L SS Electropolished 2" NPT Male Inlet | 45/20.4 | 00016145193477 | \$3,635.92 ea |
| SS24 EPE-316L | 4808907/ 70020206044 | 1 | Not Included | 250/121 | 150/1,034 | 192/727 | 24 | 316L SS Electropolished 3" — 150# Flange | 130/59 | 00016145193613 | \$8,413.47 ea |
| SS36 EPE-316L | 4808908/ 70020206051 | 1 | Not Included | 250/121 | 150/1,034 | 288/1,090 | 36 | 316L SS Electropolished 3" — 150# Flange | 140/63.5 | 00016145193620 | \$9,279.16 ea |
| SS48 EPE-316L | 4808909/ 70020206069 | 1 | Not Included | 250/121 | 150/1,034 | 384/1454 | 48 | 316L SS Electropolished 3" — 150# Flange | 150/68 | 00016145193637 | \$10,361.29 ea |

¹ Maximum operating temperature and pressure are dependent on filter cartridge — see filter specifications

Note: Max cartridge outside diameter restricted to 2-3/4"

² Flow rate based on stainless steel vessel w/ AP110 filters installed. Actual flow rate will be determined by the cartridge used.

Particulate/Scale: Alternate standard size 2-1/2" O.D. cartridges and AP420 scale/corrosion cartridges on every other cartridge post. Chlorine taste and odor: Use AP017.

| | | | |
|---------|--------|---------|---------|
| Suffix: | N/A | -2 | -3 |
| Length: | 9-3/4" | 19-1/2" | 29-1/4" |

Adding a suffix to select Aqua-Pure cartridges specifies integral length cartridges for use in multi-length housings. See page 14 for additional information.
 AP110 — 9-3/4"; AP110-2 — 19-1/2"; AP110-3 — 29-1/4"
 AP124 — 9-3/4"; AP124-2 — 19-1/2"; AP124-3 — 29-1/4"

Fit For Use Cartridges — Most Common; Refer to replacement cartridge section for more options

| Model Number | Part Number/ 3M ID | Case Lot | Size Dia. x L (inches) | Pk | Flow Rate (gpm/lpm) | Nominal Micron Rating | Description | Case Weight (lbs/kg) | UPC Code | List Price | |
|--------------|--------------------------|----------|------------------------------|----|------------------------|--------------------------|--|-------------------------|----------------|----------------|----------------|
| AP110 | 5620404/ 70020162759 | 5 2pk | 2.5 x 9.75 | NP | 8/30.3 | 5 | Standard Particulate/Rust/ Progressive Porosity/ Melt Blown | 5/2.3 | 00016145157349 | \$36.45 2pk | |
| | 5620406/ 70020162775 | 36 ea | 2.5 x 9.75 | BK | | | | 13/5.9 | | \$16.66 ea | |
| AP124 | 5620601/ 70020162833 | 5 2pk | 2.5 x 9.75 | NP | 8/30.3 | 50 | Coarse Particulate/Rust/ Progressive Porosity/ Melt Blown | 5/2.3 | 00016145157462 | \$42.39 2pk | |
| | 5620605/ 70020162874 | 36 ea | 2.5 x 9.75 | BK | | | | 13/5.9 | | \$19.47 ea | |
| AP117 | 5541705/ 70020107010 | 5 2pk | 3.0 x 9.75 | NP | 3/11.4 | 5 | Chlorine Taste & Odor/ Standard Particulate/Rust/ Melt Blown/ GAC | 13/5.9 | 00016145117008 | \$85.86 2pk | |
| | 5541706/ 70020007467 | 10 2pk | 3.0 x 9.75 | WP | | | | 25/11.3 | | 00016145106644 | \$85.86 2pk |
| | 5541714/ 70020146323 | 36 ea | 3.0 x 9.75 | BK | | | | 38/17.2 | | 00016145006784 | \$1,429.33 blk |
| APS117 | APS11701/ 70020003086 | 24 ea | 3.0 x 9.75 | ST | 3/11.4 | 5 | Chlorine Taste & Odor/ Particulate/Scale Inhibitor | 28/12.7 | 00016145106514 | \$54.13 ea | |
| AP420 | 5527407/ 70020002252 | 6 2pk | 2.94 x 9.75 | ST | 10/37.9 | 5 | Standard Particulate/Rust/ Scale Inhibitor | 16/7.3 | 00016145106385 | \$164.10 2pk | |
| AP2005 | 5588618/ 70020016922 | 5 2pk | 2.5 x 9.75 | NP | 8/30.3 | 5 | Fine Particulate/Rust/Max Temp. 170°F/76.7°C | 5/2.3 | 00016145603426 | \$44.94 2pk | |
| AP1001 | 5566601/ 70020126358 | 6 2pk | 2.5 x 9.75 | ST | 8/30.3 | 1 | Extra-fine Particulate/Rust/Max Temp. 175°F/79.4°C | 8/3.6 | 00016145123405 | \$120.74 2pk | |
| AP1003 | 5566604/ 70020126366 | 6 2pk | 2.5 x 9.75 | ST | 8/30.3 | 3 | Extra-fine Particulate/Rust/Max Temp. 175°F/79.4°C | 8/3.6 | 00016145064302 | \$91.59 2pk | |

BK = BULK PACK NP = NARROW PACK ST = STANDARD PACK WP = WIDE PACK

Note: Add suffix -2 (Example: AP110-2) for 19.5" length cartridges for use in Aqua-Pure® brand double size housings.

Scale Inhibition System



AP430SS

Scale Inhibition System

- Helps protect piping system from corrosion
- Easy to install and change-out cartridge
- Inhibits scale build-up in hot water heaters (both with and w/o tanks) & water using appliances
- Maintains efficiency and helps extend the life of hot water systems
- Stainless steel head with 3/4" inlet/outlet



Provides a consistent, controlled dose of polyphosphate scale inhibitor.

Polyphosphates sequester or bind calcium and magnesium hardness minerals, preventing them from precipitating out of solution and building up on metallic surfaces. Polyphosphates also form a thin protective layer on the pipe wall or metallic surface which helps to eliminate hardness build-up and corrosion.

Hot Water Heater Scale Inhibitor System

| Model Number | Part Number/ 3M ID | Case Lot | Ctg. Included | Pk | Maximum Temp. (°F/°C) | Flow Rate (gpm/lpm) | Description | Reduction Claims | Case Wt. (lbs/kg) | UPC Code | List Price |
|--------------|------------------------|----------|---------------|----|-----------------------|---------------------|--|------------------|-------------------|----------------|-------------|
| AP430SS | AP43010/ 7002003060 | 6 ea | AP431 | ST | 100/37.8 | 10/37.9 | In-line Scale Inhibitor System | Scale | 14/6.4 | 00016145004308 | \$124.29 ea |
| AP431 | AP43110/ 7002003078 | 10 ea | | ST | 100/37.8 | 10/37.9 | In-line Scale Inhibitor System Replacement Cartridge | Scale | 11/5 | 00016145431005 | \$51.05 ea |

ST = STANDARD PACK

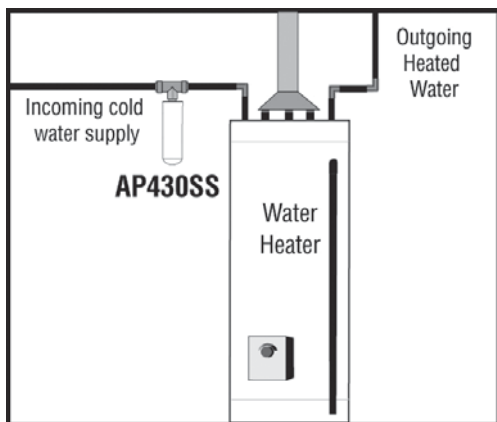

The Simplicity of the AP430SS Design

Helps provide:

- Easy installation with its 3/4" NPT Inlet/outlet connections
- Controlled dosage for maximum system performance and cartridge life (average cartridge life is 6 months)
- Easy cartridge replacement, simply screw off old cartridge and screw on new cartridge
- Although system is meant to be mounted vertically it can be mounted horizontally with the support of a bracket

Standard Diameter Whole House Replacement Cartridges

Progressive Porosity – Media Block Particulate Cartridges

- 47% More surface area than previous formulation
- 30% Longer lasting than previous formulation
- 50% More efficient than previous formulation
- Entire cartridge depth utilized
- Temperature rated for up to 170°F



5 Micron Standard Particulate/Rust

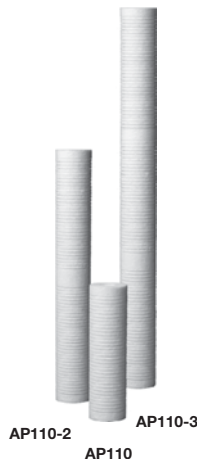

| Model Number | Part Number/ 3M ID | Case Lot | Size Dia. x L (approx.) (inches) | Pk | Flow Rate (gpm/lpm) | Nominal Micron Rating | Case Weight (lbs/kg) | UPC Code | List Price |
|--------------|-------------------------|----------|---|----|------------------------|-----------------------------|-------------------------|----------------|-------------|
| AP110 | 5620404/ 70020162759 | 5 2pk | 2.5 x 9.75 | NP | 8/30.3 | 5 | 5/2.3 | 00016145157349 | \$36.45 2pk |
| | 5620406/ 70020162775 | 36 ea | 2.5 x 9.75 | BK | | | 13/5.9 | 00016145157363 | \$16.66 ea |

NP = NARROW PACK ST = STANDARD PACK BK = BULK

Multi-Length Cartridges For Use With Aqua-Pure® Brand Filter Housings

| | | | | | | | | | |
|---------|-------------------------|-------|-------------|----|---------|---|--------|----------------|------------|
| AP110-2 | 5620405/ 70020162767 | 15 ea | 2.5 x 19.5 | ST | 16/60.6 | 5 | 12/5.4 | 00016145157356 | \$32.81 ea |
| AP110-3 | 5620409/ 70020162791 | 15 ea | 2.5 x 29.25 | ST | 24/90.8 | 5 | 16/7.3 | 00016145157387 | \$47.93 ea |

ST = STANDARD PACK

Multi-Length Cartridges For Use With Other Brand Filter Housings

| | | | | | | | | | |
|----------|-------------------------|-------|----------|----|---------|---|--------|----------------|------------|
| AP110-2C | 5620410/ 70020182146 | 15 ea | 2.5 x 20 | ST | 16/60.6 | 5 | 12/5.4 | 00016145176609 | \$32.07 ea |
| AP110-3C | 5620411/ 70020182153 | 15 ea | 2.5 x 30 | ST | 24/90.8 | 5 | 17/7.7 | 00016145176616 | \$46.91 ea |

ST = STANDARD PACK

50 Micron Coarse Particulate/Rust

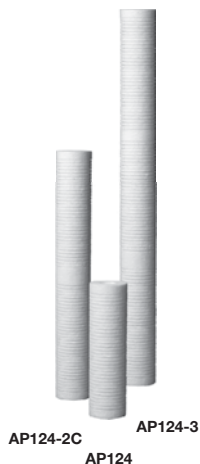

| Model Number | Part Number/ 3M ID | Case Lot | Size Dia. x L (approx.) (inches) | Pk | Flow Rate (gpm/lpm) | Nominal Micron Rating | Case Weight (lbs/kg) | UPC Code | List Price |
|--------------|-------------------------|----------|---|----|------------------------|-----------------------------|-------------------------|----------------|-------------|
| AP124 | 5620601/ 70020162833 | 5 2pk | 2.5 x 9.75 | NP | 8/30.3 | 50 | 5/2.3 | 00016145157424 | \$42.39 2pk |
| | 5620605/ 70020162874 | 36 ea | 2.5 x 9.75 | BK | | | 13/5.9 | 00016145157462 | \$19.47 ea |

NP = NARROW PACK ST = STANDARD PACK BK = BULK

Multi-Length Cartridges For Use With Aqua-Pure Brand Filter Housings

| | | | | | | | | | |
|----------|-------------------------|-------|-------------|----|---------|----|--------|----------------|------------|
| AP124-2C | 5620603/ 70020162858 | 15 ea | 2.5 x 20 | ST | 16/60.6 | 50 | 10/4.6 | 00016145157448 | \$33.55 ea |
| AP124-3 | 5620604/ 70020162866 | 15 ea | 2.5 x 29.25 | ST | 24/90.8 | 50 | 16/7.3 | 00016145157455 | \$47.93 ea |

ST = STANDARD PACK

Ultra-Fine & Extra-Fine Particulate Replacement Cartridges

- High Temperature Cartridges
- Ultra-Fine for Clay, Silt & Colloidal Particulate
- Extra-Fine Particulate for water polishing and final phase filtration

Extra-Fine Particulate



AP1001 AP1003

| Model Number | Part Number/ 3M ID | Case Lot | Size Dia. x L (approx.) (inches) | Pk | Maximum Temp (°F/°C) | Flow Rate (gpm/lpm) | Nominal Micron Rating | Case Weight (lbs/kg) | UPC Code | List Price |
|--------------|-------------------------|----------|----------------------------------|----|----------------------|---------------------|-----------------------|----------------------|----------------|----------------|
| AP1001 | 5566601/ 70020126358 | 6 2pk | 2.5 x 9.75 | ST | 175/79.4 | 8/30.3 | 1 | 8/3.6 | 00016145123405 | \$120.74 2pk |
| | 5566602/ 70020146380 | 24 ea | 2.5 x 9.75 | BK | 175/79.4 | 8/30.3 | 1 | 16/7.3 | 00016145107122 | \$1,317.66 blk |
| AP1003 | 5566604/ 70020126366 | 6 2pk | 2.5 x 9.75 | ST | 175/79.4 | 8/30.3 | 3 | 8/3.6 | 00016145064302 | \$91.59 2pk |

ST = STANDARD PACK BK = BULK PACK

Hot Water, Chemical Compatibility, Backwash

Hot Water Applications up to 170°F

- Bicomponent polypropylene/polyethylene fiber for broad chemical compatibility
- Free of Media Migration for filtration applications
- Backwash applications

5 Micron Nominal Fine Particulate/Rust



AP2005

| Model Number | Part Number/ 3M ID | Case Lot | Size Dia. x L (approx.) (inches) | Pk | Maximum Temp (°F/°C) | Flow Rate (gpm/lpm) | Nominal Micron Rating | Case Weight (lbs/kg) | UPC Code | List Price |
|--------------|-------------------------|----------|----------------------------------|----|----------------------|---------------------|-----------------------|----------------------|----------------|-------------|
| AP2005 | 5588618/ 70020016922 | 5 2pk | 2.5 x 9.75 | NP | 170/76.7 | 8/30.3 | 5 | 5/2.3 | 00016145603426 | \$44.94 2pk |

NP = NARROW PACK

Multi-Length Cartridges For Use With Aqua-Pure® Brand Filter Housings

| | | | | | | | | | | |
|----------|-------------------------|-------|------------|----|----------|---------|---|--------|----------------|------------|
| AP2005-2 | 5588627/ 70020016971 | 15 ea | 2.5 x 19.5 | ST | 170/76.7 | 16/60.6 | 5 | 12/5.4 | 00016145074387 | \$40.82 ea |
|----------|-------------------------|-------|------------|----|----------|---------|---|--------|----------------|------------|

ST = STANDARD PACK

Ungrooved Particulate Cartridges (Not rated for high temperatures & for use with most competitive housings)



GRMB Series

| Model/Part Number | 3M ID | Case Lot | Size Dia. x L (approx.) (inches) | Pk | Maximum Temp (°F/°C) | Flow Rate (gpm/lpm) | Nominal Micron Rating | Case Weight (lbs/kg) | UPC Code | List Price |
|-------------------|-------------|----------|----------------------------------|----|----------------------|---------------------|-----------------------|----------------------|----------------|------------|
| GRMB01PP10UB | 70020249853 | 36 | 2.5 x 10 | ST | 100/37.8 | 8/30.3 | 1 | 15.4/7.0 | 00016145233333 | \$5.50 ea |
| GRMB01PP20UB | 70020249861 | 15 | 2.5 x 20 | ST | 100/37.8 | 16/60.5 | 1 | 12.9/5.9 | 00016145233340 | \$10.16 ea |
| GRMB01PP30UB | 70020249721 | 15 | 2.5 x 30 | ST | 100/37.8 | 24/90.8 | 1 | 19.2/8.7 | 00016145233203 | \$14.82 ea |
| GRMB05PP10UB | 70020249879 | 36 | 2.5 x 10 | ST | 100/37.8 | 8/30.3 | 5 | 15.4/7.0 | 00016145233357 | \$5.50 ea |
| GRMB05PP20UB | 70020249887 | 15 | 2.5 x 20 | ST | 100/37.8 | 16/60.5 | 5 | 12.9/5.9 | 00016145233364 | \$10.16 ea |
| GRMB05PP30UB | 70020249895 | 15 | 2.5 x 30 | ST | 100/37.8 | 24/90.8 | 5 | 19.2/8.7 | 00016145233371 | \$14.82 ea |
| GRMB10PP10UB | 70020249903 | 36 | 2.5 x 10 | ST | 100/37.8 | 8/30.3 | 10 | 15.4/7.0 | 00016145233388 | \$5.50 ea |
| GRMB10PP20UB | 70020249911 | 15 | 2.5 x 20 | ST | 100/37.8 | 16/60.5 | 10 | 12.9/5.9 | 00016145233395 | \$10.16 ea |
| GRMB10PP30UB | 70020249929 | 15 | 2.5 x 30 | ST | 100/37.8 | 24/90.8 | 10 | 19.2/8.7 | 00016145233401 | \$14.82 ea |
| GRMB20PP10UB | 70020249937 | 36 | 2.5 x 10 | ST | 100/37.8 | 8/30.3 | 20 | 15.4/7.0 | 00016145233418 | \$5.50 ea |
| GRMB20PP20UB | 70020249945 | 15 | 2.5 x 20 | ST | 100/37.8 | 16/60.5 | 20 | 12.9/5.9 | 00016145233425 | \$10.16 ea |
| GRMB20PP30UB | 70020249952 | 15 | 2.5 x 30 | ST | 100/37.8 | 24/90.8 | 20 | 19.2/8.7 | 00016145233432 | \$14.82 ea |
| GRMB50PP10UB | 70020249960 | 36 | 2.5 x 10 | ST | 100/37.8 | 8/30.3 | 50 | 15.4/7.0 | 00016145233449 | \$5.50 ea |
| GRMB50PP20UB | 70020249978 | 15 | 2.5 x 20 | ST | 100/37.8 | 16/60.5 | 50 | 12.9/5.9 | 00016145233456 | \$10.16 ea |
| GRMB50PP30UB | 70020249986 | 15 | 2.5 x 30 | ST | 100/37.8 | 24/90.8 | 50 | 19.2/8.7 | 00016145233463 | \$14.82 ea |

ST = STANDARD PACK

Whole House Replacement Cartridges

Reduces: Particulate, Dirt, Rust, Scale, Chlorine Taste & Odor (CTO)
 Formats: GAC, Modified and Extruded Carbon Block Formulations & Scale inhibition

Chlorine Taste & Odor Replacement Cartridges



AP117

| Model Number | Part Number/ 3M ID | Case Lot | Size Dia. x L (inches) | Pk | Maximum Temp (°F/°C) | Flow Rate (gpm/lpm) | Nominal Micron Rating | Case Weight (lbs/kg) | UPC Code | List Price |
|--------------|-------------------------|----------|------------------------|----|----------------------|---------------------|-----------------------|----------------------|----------------|----------------|
| AP117 | 5541705/ 70020107010 | 5 2pk | 3.0 x 9.75 | NP | 100/37.8 | 3/11.4 | 5 | 13/5.9 | 00016145117008 | \$85.86 2pk |
| | 5541706/ 70020007467 | 10 2pk | 3.0 x 9.75 | WP | | | | 25/11.3 | 00016145106644 | \$85.86 2pk |
| | 5541714/ 70020146323 | 36 ea | 3.0 x 9.75 | BK | | | | 38/17.2 | 00016145006784 | \$1,429.33 blk |
| AP017 | 5552807/ 70020146364 | 24 ea | 2.75 x 9.75 | BK | 100/37.8 | 2/7.6 | 5 | 24/10.9 | 00016145106705 | \$748.02 blk |
| AP117RO | 5577801/ 7002015676 | 36 ea | 3.0 x 9.75 | BK | 100/37.8 | 3/11.4 | 5 | 42/19.1 | 00016145073946 | \$41.41 ea |

BK = BULK PACK NP = NARROW PACK ST = STANDARD PACK WP = WIDE PACK

5 Micron Fine Particulate with Scale Inhibitor



AP420

| Model Number | Part Number/ 3M ID | Case Lot | Size Dia. x L (inches) | Pk | Maximum Temp (°F/°C) | Flow Rate (gpm/lpm) | Nominal Micron Rating | Case Weight (lbs/kg) | UPC Code | List Price |
|--------------|-------------------------|----------|------------------------|----|----------------------|---------------------|-----------------------|----------------------|----------------|--------------|
| AP420 | 5527407/ 70020002252 | 6 2pk | 2.94 x 9.75 | ST | 100/37.8 | 10/37.9 | 5 | 16/7.3 | 00016145601095 | \$164.10 2pk |

ST = STANDARD PACK

Chlorine Taste & Odor w/Scale Inhibitor Replacement Cartridges



APS117

| Model Number | Part Number/ 3M ID | Case Lot | Size Dia. x L (inches) | Pk | Maximum Temp (°F/°C) | Flow Rate (gpm/lpm) | Nominal Micron Rating | Case Weight (lbs/kg) | UPC Code | List Price |
|--------------|--------------------------|----------|------------------------|----|----------------------|---------------------|-----------------------|----------------------|----------------|------------|
| APS117 | APS11701/ 70020003086 | 24 ea | 3.0 x 9.75 | BK | 100/37.8 | 3/11.4 | 5 | 28/12.7 | 00016145106514 | \$54.13 ea |

ST = STANDARD PACK

Large Diameter Whole House Replacement Cartridges

Large Diameter Replacement Cartridges for AP800 Series Systems

Large Diameter Particulate



| Model Number | Part Number/ 3M ID | Case Lot | Size Dia. x L (in) (approx.) | Pk | Flow Rate (gpm/lpm) | Nominal Micron Rating | Case Weight (lbs/kg) | UPC Code | List Price |
|--------------|-------------------------|----------|---------------------------------|----|---------------------|-----------------------|----------------------|----------------|------------|
| AP810 | 5618902/ 70020164177 | 4 ea | 4.5 x 9.75 | ST | 20/75.7 | 5 | 4/1.8 | 00016145158766 | \$48.04 ea |
| AP810-2 | 5618903/ 70020162437 | 4 ea | 4.5 x 20 | ST | 45/170.3 | 5 | 11/5 | 00016145157028 | \$84.20 ea |
| AP811 | 5618904/ 70020170547 | 4 ea | 4.5 x 9.75 | ST | 20/75.7 | 25 | 5/2.3 | 00016145165108 | \$58.08 ea |
| AP811-2 | 5618905/ 70020176742 | 4 ea | 4.5 x 20 | ST | 45/170.3 | 25 | 11/5 | 00016145171277 | \$93.05 ea |
| AP814 | 5599401/ 70020105329 | 4 ea | 4.5 x 9.75 | ST | 20/75.7 | 50 | 7/3.2 | 00016145811418 | \$44.14 ea |
| AP814-2 | 5599403/ 70020105337 | 4 ea | 4.5 x 20 | ST | 45/170.3 | 50 | 16/7.3 | 00016145814204 | \$87.30 ea |

ST = STANDARD PACK

Large Diameter Chlorine Taste & Odor (Maximum Temperature: 100°F/37.8°C)



| Model Number | Part Number/ 3M ID | Case Lot | Size Dia. x L (in) (approx.) | Pk | Flow Rate (gpm/lpm) | Nominal Micron Rating | Case Weight (lbs/kg) | UPC Code | List Price |
|--------------|-------------------------|----------|---------------------------------|----|---------------------|-----------------------|----------------------|----------------|-------------|
| AP817 | 5602701/ 70020169648 | 4 ea | 4.5 x 9.75 | ST | 10/37.9 | 25 | 7/3.2 | 00016145164200 | \$76.80 ea |
| AP817-2 | 5602707/ 70020169671 | 4 ea | 4.5 x 20 | ST | 20/75.7 | 25 | 25/11.3 | 00016145164231 | \$152.94 ea |

ST = STANDARD PACK

Note: It is always recommended to install a 5 micron prefilter before a chlorine taste & odor filter in whole house applications.



COMPONENT

Sanitary Quick Change (SQC) AP900 Series Replacement Cartridges

AP900 Series Replacement Cartridges



| Model Number | Part Number/ 3M ID | Case Lot | Size Dia. x L (in) (approx.) | Pk | Flow Rate (gpm/lpm) | Nominal Micron Rating | Case Weight (lbs/kg) | UPC Code | List Price |
|--------------|-------------------------|----------|---------------------------------|----|---------------------|-----------------------|----------------------|----------------|-------------|
| AP910R | 5621001/ 70020204460 | 1 | 4.5 x 29 | ST | 20/75.7 | 5 | 3/1.4 | 00016145192043 | \$204.32 ea |
| AP917HD | 5621006/ 70020269687 | 1 | 4.5 x 29 | ST | 20/75.7 | 5 | 3/1.4 | 00016145252303 | \$279.33 ea |
| AP917HD-S | 5621008/ 70020273929 | 1 | 4.5 x 29 | ST | 20/75.7 | 5 | 3.5/1.6 | 00016145256547 | \$343.29 ea |

ST = STANDARD PACK



COMPONENT

Aqua-Pure® Ultraviolet Light Systems

APUV1



APUV1

| Part Number/ 3M ID | Case Lot | Description | Flow Rate (gpm/lpm) | Application | Case Weight (lbs/kg) | UPC Code | List Price |
|-------------------------|----------|-------------|------------------------|--------------------------|-------------------------|----------------|--------------------|
| 5605801/ 70020018811 | 1 | System | 1/3.8 | Point Of Use — Undersink | 5/2.3 | 00016145107542 | \$799.02 ea |
| 5605831/ 70020125988 | 1 | Bulb | N/A | Replacement Bulb | | 00016145123726 | \$154.39 ea |
| 5605832/ 70020125996 | 1 | Sleeve | N/A | Replacement Sleeve | | 00016145123733 | \$65.04 ea |
| 5605859/ 70020018951 | 1 | Ballast | N/A | Replacement Ballast | | 00016145008306 | \$246.59 ea |
| 5605861/ 70020018977 | 1 | Power Cord | N/A | Replacement Power Cord | | 00016145008320 | \$19.17 ea |
| 5605862/ 70020018985 | 1 | O-rings | N/A | Replacement O-rings | | 00016145008337 | \$2.70 ea |

APUV2



APUV2

| Part Number/ 3M ID | Case Lot | Description | Flow Rate (gpm/lpm) | Application | Case Weight (lbs/kg) | UPC Code | List Price |
|-------------------------|----------|-------------|------------------------|--------------------------|-------------------------|----------------|--------------------|
| 5605802/ 70020018829 | 1 | System | 2/7.6 | Point Of Use — Undersink | 6/2.7 | 00016145107559 | \$822.18 ea |
| 5605833/ 70020018878 | 1 | Bulb | N/A | Replacement Bulb | | 00016145107603 | \$154.38 ea |
| 5605834/ 70020018886 | 1 | Sleeve | N/A | Replacement Sleeve | | 00016145107610 | \$68.96 ea |
| 5605859/ 70020018951 | 1 | Ballast | N/A | Replacement Ballast | | 00016145008306 | \$246.59 ea |
| 5605861/ 70020018977 | 1 | Power Cord | N/A | Replacement Power Cord | | 00016145008320 | \$19.17 ea |
| 5605862/ 70020018985 | 1 | O-rings | N/A | Replacement O-rings | | 00016145008337 | \$2.70 ea |

APUV5



APUV5

| Part Number/ 3M ID | Case Lot | Description | Flow Rate (gpm/lpm) | Application | Case Weight (lbs/kg) | UPC Code | List Price |
|-------------------------|----------|-------------|------------------------|------------------------|-------------------------|----------------|--------------------|
| 5605803/ 70020018837 | 1 | System | 5/18.9 | Small House — Cottage | 6/2.7 | 00016145107566 | \$982.18 ea |
| 5605835/ 70020018894 | 1 | Bulb | N/A | Replacement Bulb | | 00016145107627 | \$156.30 ea |
| 5605836/ 70020018902 | 1 | Sleeve | N/A | Replacement Sleeve | | 00016145107634 | \$86.96 ea |
| 5605859/ 70020018951 | 1 | Ballast | N/A | Replacement Ballast | | 00016145008306 | \$246.59 ea |
| 5605861/ 70020018977 | 1 | Power Cord | N/A | Replacement Power Cord | | 00016145008320 | \$19.17 ea |
| 5605862/ 70020018985 | 1 | O-rings | N/A | Replacement O-rings | | 00016145008337 | \$2.70 ea |

APUV8



APUV8

| Part Number/ 3M ID | Case Lot | Description | Flow Rate (gpm/lpm) | Application | Case Weight (lbs/kg) | UPC Code | List Price |
|-------------------------|----------|-------------|------------------------|------------------------|-------------------------|----------------|----------------------|
| 5605804/ 70020018845 | 1 | System | 8/30.3 | Whole House | 10/4.5 | 00016145107573 | \$1,477.13 ea |
| 5605837/ 70020018910 | 1 | Bulb | N/A | Replacement Bulb | | 00016145107641 | \$162.54 ea |
| 5605838/ 70020018928 | 1 | Sleeve | N/A | Replacement Sleeve | | 00016145107658 | \$90.44 ea |
| 5605859/ 70020018951 | 1 | Ballast | N/A | Replacement Ballast | | 00016145008306 | \$246.59 ea |
| 5605861/ 70020018977 | 1 | Power Cord | N/A | Replacement Power Cord | | 00016145008320 | \$19.17 ea |
| 5605862/ 70020018985 | 1 | O-rings | N/A | Replacement O-rings | | 00016145008337 | \$2.70 ea |

Water Treatment

The Challenge:

Taking advantage of the growth trend in water treatment. Many households in the United States have water quality concerns. Based on estimates from the U.S. Geological Survey, over 85% of homes have hard water problems. The demand in North America for water treatment products is expected to grow to \$22.7 billion in 2015

The Solution:

3M Aqua-Pure® Water Treatment
Broad portfolio of softening and water treatment solutions.
Specific contaminant reduction for problem water include arsenic, tannin, iron, manganese and more....

Now it is even easier to do business with 3M Purification Inc. New for 2014 – The Aqua-Pure water treatment free freight and volume discounts are here to stay. No longer just a promotion, these programs help maximize your profits every time you sell a system.

- Volume discounts – The more you buy the more you save. Purchase 3-6 water treatment systems and receive a 10% discount per unit. Buy 7 + water treatment systems per order and receive a 15% discount per unit
- Free Freight – Free Freight on purchases of three or more units of applicable water treatment products, with NO dollar minimum
- Faster Delivery – Top selling SKUs shipped within 3 days of order placement (see truck icons)
- Newly –redesigned media tank equipped with threaded tank to valve connections
- Dome Hole Tank models available designed for easier media replacement
- Water Test Kits to help you grow your 3M Aqua-Pure® Water Treatment Business



CWS Series



CBW Series CBWDM Series CBF Series CBFDM Series



APIF100 Series APIF100DM Series

Water Softener Systems

Hard Water: Softening helps reduce dissolved "rock-hard minerals" from your water. Water naturally dissolves these minerals in the ground just like adding sugar to a glass of water. Hot water reverses this process and causes the "hardness" in your water to reform as rock-hard scale inside your water heater, pipes and appliances, on your sinks, tubs, shower-heads, dishes and in your laundry. Skin and hair absorb these hard-minerals, filling pores and hair follicles with "earth".

Benefits of Aqua-Pure® Water Softeners:

- **Cleaner Bathing** — Bathing in softened water results in healthier looking and better feeling skin. Your hair will wash and rinse easier showing it's natural beauty.
 - **Cleaner and Brighter Laundry** — Detergents work better, Laundry last longer
 - **Faster and Easier Cleaning** — No more soap scum and mineral deposits
 - **Sparkling Dishes** — Reduces spotting (scale deposits after water evaporates) or cloudy film.
 - **Helps Protect Your Plumbing** — Perhaps the greatest damage done by hard water is what you don't see; mineral deposits that can build-up and clog pipes.
- Aqua-Pure water softeners help reduce mineral build-up and lengthen the life of water-using appliances such as dishwashers, clothes washers and water heaters.
- **Save Time and Money** — Spend less time cleaning. Use less detergents and save up to 30% on hot water heating bills.



CWS Series — High Flow — Metered

Features:

- Smart electronics with coin style lithium ion battery backup — monitors water consumption and automatically adjusts to changing water usage
- Distributor resin scrubber
- Fully ported four way bypass valve with durable connection fittings
- Quick and Easy installations (manual included)
- Multi-tiered salt shelf allows for use of most kinds of water softener salt
- Choice of either natural or black colored media tanks
- Models supplied with both standard resin and fine mesh resin to address a variety of water problems

* Compact, Space saving models available



CWS Series — High Flow — Metered Electronic Control Valve



Purchase 3-6 water treatment systems per order and receive a 10% discount per unit. Buy 7 + water treatment systems per order and receive a 15% discount per unit.

| Product Type | Model Number | Part Number/ 3M ID | Media Cu. Ft. | Media Incl. | Maximum Capacity Grains | Flow Rate @ 15 psid (gpm/ppm) | Space Req. L x W x H (approx.) | Case Lot | Case Wt. (lbs/kg) | UPC Code | List Price | |
|--------------------------------|----------------------------|----------------------------|------------------|-------------|----------------------------|-------------------------------------|--------------------------------------|-----------------|----------------------|----------------|----------------|---------------|
| Electronic Metered Valve | CWS100ME | CWS100ME/ 70020129121 | 1.0 | HCP | 28,500 | 7.9/29.9 | 15" x 33" x 53" | 1 | 97/44.0 | 00092498004776 | \$1,884.90 ea | |
| | CWS150ME | CWS150ME/ 70020129139 | 1.5 | HCP | 43,000 | 11.1/42.0 | 15" x 35" x 53" | 1 | 125/56.7 | 00092498004783 | \$2,054.85 ea | |
| | CWS200ME | CWS200ME/ 70020129147 | 2.0 | HCP | 56,800 | 9.6/36.3 | 15" x 35" x 63" | 1 | 154/69.9 | 00092498004790 | \$2,219.65 ea | |
| | CWS300ME | CWS300ME/ 70020129154 | 3.0 | HCP | 87,800 | 15.7/59.4 | 18" x 42" x 74" | 1 | 244/110.7 | 00092498004806 | \$3,362.95 ea | |
| | CWS100MEJ | CWS100MEJ/ 70020234723 | 1.0 | HCP | 28,500 | 7.9/29.9 | 15" x 33" x 53" | 1 | 97/44.0 | 00016145215919 | \$1,926.10 ea | |
| | CWS150MEJ | CWS150MEJ/ 70020234731 | 1.5 | HCP | 43,000 | 11.1/42.0 | 15" x 35" x 53" | 1 | 125/56.7 | 00016145215926 | \$2,096.05 ea | |
| | CWS200MEJ | CWS200MEJ/ 70020234749 | 2.0 | HCP | 56,800 | 9.6/36.3 | 15" x 35" x 63" | 1 | 154/69.9 | 00016145215933 | \$2,271.15 ea | |
| | CWS300MEJ | CWS300MEJ/ 70020234756 | 3.0 | HCP | 87,800 | 15.7/59.4 | 18" x 42" x 74" | 1 | 244/110.7 | 00016145215940 | \$3,502.00 ea | |
| | CWS100MECJ | CWS100MECJ/ 70020182534 | 1.0 | HCP | 28,500 | 7.9/29.9 | 15" x 33" x 53" | 1 | 97/44.0 | 00016145176999 | \$2,013.65 ea | |
| | CWS150MECJ | CWS150MECJ/ 70020182542 | 1.5 | HCP | 43,000 | 11.1/42.0 | 15" x 35" x 53" | 1 | 125/56.7 | 00016145177002 | \$2,214.50 ea | |
| | CWS200MECJ | CWS200MECJ/ 70020182559 | 2.0 | HCP | 56,800 | 9.6/36.3 | 15" x 35" x 63" | 1 | 154/69.9 | 00016145177019 | \$2,379.30 ea | |
| | CWS300MECJ | CWS300MECJ/ 70020234905 | 3.0 | HCP | 87,800 | 15.7/59.4 | 18" x 42" x 74" | 1 | 244/110.7 | 00016145216091 | \$3,651.35 ea | |
| | CWSX100ME | CWSX100ME/ 70020231810 | 1.0 | | FM | 28,500 | 7.9/29.9 | 15" x 33" x 53" | 1 | 97/44.0 | 00016145214042 | \$2,023.95 ea |
| | CWSX150ME | CWSX150ME/ 70020231828 | 1.5 | | FM | 43,000 | 11.1/42.0 | 15" x 35" x 53" | 1 | 125/56.7 | 00016145214059 | \$2,193.90 ea |
| | CWSX200ME | CWSX200ME/ 70020231836 | 2.0 | | FM | 56,800 | 9.6/36.3 | 15" x 35" x 63" | 1 | 154/69.9 | 00016145214066 | \$2,358.70 ea |
| | CWSX100MEJ | CWSX100MEJ/ 70020234715 | 1.0 | | FM | 28,500 | 7.3/27.6 | 15" x 33" x 53" | 1 | 97/44.0 | 00016145215902 | \$2,065.15 ea |
| CWSX200MEJ | CWSX200MEJ/ 70020234897 | 2.0 | | FM | 56,800 | 9.6/36.3 | 15" x 35" x 63" | 1 | 154/69.9 | 00016145216084 | \$2,410.20 ea | |

FM = Fine Mesh Resin HCP = Hi-Cap Resin CJ = Chrome Jacket Model



= Shipped within 3 days of order placement

CWS High Flow Series

| | | | | | | | | | | | | |
|--------------------------------|-----------|---------------------------|-----|--|----|--------|----------|-----------------|---|---------|----------------|---------------|
| Electronic Metered Valve | CWS100MEX | CWS100MEX/ 70020231844 | 1.0 | | FM | 28,500 | 7.3/27.6 | 15" x 33" x 44" | 1 | 97/44.0 | 00016145214073 | \$2,188.75 ea |
|--------------------------------|-----------|---------------------------|-----|--|----|--------|----------|-----------------|---|---------|----------------|---------------|

FM = Fine Mesh Resin

CWS — SpaceMaker Cabinet Style Design

| | | | | | | | | | | | |
|--------------------------------|-----------|---------------------------|-----|-----|--------|----------|-----------------|---|---------|----------------|---------------|
| Electronic Metered Valve | CWSL100ME | CWSL100ME/ 70020252022 | 1.0 | HCP | 28,500 | 7.3/27.6 | 26" x 11" x 45" | 1 | 97/44.0 | 00016145214035 | \$2,151.43 ea |
|--------------------------------|-----------|---------------------------|-----|-----|--------|----------|-----------------|---|---------|----------------|---------------|

HCP = Hi-Cap Resin



NWS Series

The Original Aqua-Pure® Softener Series!

Features:

- Time proven control valve performance
- Distributor resin scrubber
- Safety brine valve assembly included to prevent brine tank overflow
- Multi-tiered salt shelf allows for use of most water softener salt
- Full ported bypass valve with durable 1" NPT connections
- Installation & operation manual included

NEW Purchase 3-6 water treatment systems per order and receive a 10% discount per unit. Buy 7 + water treatment systems per order and receive a 15% discount per unit.

NWS Series Residential Softeners

| Product Type | Model Number | Part Number/ 3M ID | Media Cu. Ft. | Media Incl. | Maximum Capacity Grains | Flow Rate (gpm/ppm) | Space Req. L x W x H (approx.) | Case Lot | Case Wt. (lbs/kg) | UPC Code | List Price |
|--------------------------|--------------|-------------------------|------------------|-------------|----------------------------|------------------------|-----------------------------------|----------|----------------------|----------------|---------------|
| Time Clock Fleck 5600 | NWS100 | 5564002/ 70020006006 | 1.0 | HCP | 30,000 | 7/26.5 | 34" x 16" x 52" | 1 | 90/40.8 | 00016145118661 | \$1,997.17 ea |
| | NWS150 | 5564003/ 70020103233 | 1.5 | HCP | 45,000 | 8/30.3 | 36" x 17" x 52" | 1 | 117/53.1 | 00016145214080 | \$2,203.17 ea |
| | NWS200 | 5564004/ 70020103241 | 2.0 | HCP | 56,000 | 8.5/32.2 | 36" x 17" x 62" | 1 | 142/64.4 | 00016145214097 | \$2,409.17 ea |
| Metered Fleck 5600 | NWS100M | 5564006/ 70020006014 | 1.0 | HCP | 30,000 | 7/26.5 | 34" x 16" x 52" | 1 | 89/40.4 | 00016145060137 | \$2,240.25 ea |
| | NWS150M | 5564007/ 70020103266 | 1.5 | HCP | 45,000 | 8/30.3 | 36" x 17" x 52" | 1 | 116/52.6 | 00016145060175 | \$2,446.25 ea |
| | NWS200M | 5564008/ 70020103274 | 2.0 | HCP | 56,000 | 8.5/32.2 | 36" x 17" x 62" | 1 | 141/64.0 | 00016145060182 | \$2,652.25 ea |

HCP = Hi-Cap Resin



AWS Series

Features:

- Smart electronics with 9-volt backup — monitors water consumption and automatically adjusts to changing water usage
- Distributor resin scrubber
- Safety brine valve assembly included to prevent brine tank overflow
- Multi-tiered salt shelf allows for use of most water softener salt
- Bypass valve supplied with 1" solder connections
- High capacity softener resin
- Installation & operation manual included

NEW Purchase 3-6 water treatment systems per order and receive a 10% discount per unit. Buy 7 + water treatment systems per order and receive a 15% discount per unit.

AWS Series — Advanced Water Softeners — CAM Electronic Controller

| Product Type | Model Number | Part Number/ 3M ID | Media Cu. Ft. | Media Incl. | Maximum Capacity Grains | Flow Rate (gpm/ppm) | Space Req. L x W x H (approx.) | Case Lot | Case Wt. (lbs/kg) | UPC Code | List Price |
|-----------------------------------|--------------|-------------------------|------------------|-------------|----------------------------|------------------------|-----------------------------------|----------|----------------------|----------------|---------------|
| Electronic Metered Softener | AWS100M | AWS100M/ 70020092600 | 1.0 | HCP | 30,000 | 11.2/42.4 | 34" x 18" x 51" | 1 | 100/45.4 | 00092498003052 | \$2,163.00 ea |
| | AWS150M | AWS150M/ 70020092618 | 1.5 | HCP | 45,000 | 14.0/53.0 | 36" x 18" x 51" | 1 | 125/56.7 | 00092498003069 | \$2,332.95 ea |
| | AWS200M | AWS200M/ 70020092626 | 2.0 | HCP | 60,000 | 12.7/48.1 | 36" x 18" x 61" | 1 | 150/68 | 00092498003076 | \$2,564.70 ea |
| | AWS300M | AWS300M/ 70020047497 | 3.0 | HCP | 84,000 | 17.0/64.4 | 40" x 18" x 77" | 1 | 300/136.1 | 00092498002918 | \$3,805.85 ea |

HCP = Hi-Cap Resin



CS/CSM Series - Water Softeners

Features:

- AB 1953 certified brass valve with time proven performance history
- Safety brine valve assembly included to prevent brine tank overflow
- Multi-tiered salt shelf allows for use of most water softener salt
- Models with either a time clock or meter initiated timer assembly
- Models available in both natural and black colored media tanks
- Regeneration programming is fully adjustable conserving on water during regeneration
- Distributor resin scrubber
- Bypass valve supplied with 1" NPT connections
- High capacity softener resin
- Installation & operation manual included

NEW Purchase 3-6 water treatment systems per order and receive a 10% discount per unit. Buy 7 + water treatment systems per order and receive a 15% discount per unit.

CS/CSM Series — CEC1000 Brass Valve

| Product Type | Model Number | Part Number/ 3M ID | Media Cu. Ft. | Media Incl. | Maximum Capacity Grains | Flow Rate (gpm/ppm) | Space Req. L x W x H (approx.) | Case Lot | Case Wt. (lbs/kg) | UPC Code | List Price |
|--|--------------|--------------------------|------------------|-------------|----------------------------|------------------------|-----------------------------------|----------|----------------------|----------------|---------------|
| AB 1953 Certified Brass Valve Time Clock CEC1000 | CS1001 | CS1001/ 70020093863 | 1.0 | HCP | 30,000 | 7.5/28 | 30" x 15" x 51" | 1 | 103/46.7 | 00016145054525 | \$2,832.50 ea |
| | CS1001J | CS1001J/ 70020093897 | 1.0 | HCP | 30,000 | 7.5/28 | 30" x 15" x 51" | 1 | 103/46.7 | 00016145054556 | \$2,868.55 ea |
| | CS1501 | CS1501/ 70020093939 | 1.5 | HCP | 45,000 | 9.0/34 | 30" x 15" x 51" | 1 | 131/59.4 | 00016145054594 | \$3,002.45 ea |
| | CS1501J | CS1501J/ 70020093962 | 1.5 | HCP | 45,000 | 9.0/34 | 30" x 15" x 51" | 1 | 131/59.4 | 00016145054624 | \$3,012.75 ea |
| | CS2001 | CS2001/ 70020093996 | 2.0 | HCP | 60,000 | 9.0/34 | 30" x 15" x 61" | 1 | 160/72.6 | 00016145054655 | \$2,992.15 ea |
| | CS2001J | CS2001J/ 70020094028 | 2.0 | HCP | 60,000 | 9.0/34 | 30" x 15" x 61" | 1 | 160/72.6 | 00016145054686 | \$3,028.20 ea |
| AB 1953 Certified Brass Valve Metered CEC1000 | CSM1001 | CSM1001/ 70020093624 | 1.0 | HCP | 30,000 | 7.5/28 | 30" x 15" x 51" | 1 | 103/46.7 | 00016145054297 | \$2,914.90 ea |
| | CSM1001J | CSM1001J/ 70020093657 | 1.0 | HCP | 30,000 | 7.5/28 | 30" x 15" x 51" | 1 | 103/46.7 | 00016145054327 | \$2,950.95 ea |
| | CSM1501 | CSM1501/ 70020093681 | 1.5 | HCP | 45,000 | 9.0/34 | 30" x 15" x 51" | 1 | 131/59.4 | 00016145054358 | \$3,084.85 ea |
| | CSM1501J | CSM1501J/ 70020093715 | 1.5 | HCP | 45,000 | 9.0/34 | 30" x 15" x 51" | 1 | 131/59.4 | 00016145054389 | \$3,120.90 ea |
| | CSM2001 | CSM2001/ 70020093731 | 2.0 | HCP | 60,000 | 9.0/34 | 30" x 15" x 61" | 1 | 160/72.6 | 00092498002765 | \$4,130.30 ea |
| | CSM2001J | CSM2001J/ 70020093756 | 2.0 | HCP | 60,000 | 9.0/34 | 30" x 15" x 61" | 1 | 160/72.6 | 00016145054419 | \$4,166.35 ea |

HCP = Hi-Cap Resin

N.A. = Not available at time of document release.

Problem Water Systems

Arsenic Reduction Systems



ASB Series — Arsenic Reduction Backwash System

Fully Automatic Controls

- Smart electronics with coin style lithium ion battery backup
- Complete pre-packaged, ready to go
- Fully ported four way bypass valve with durable connection fittings
- Includes high quality quartz filter gravel underbed to:
 - support filter media
 - reduce pressure differential through filter unit at peak flow rates
 - provide even backwash through the diameter of the media tank during regeneration
- High flow distributor with self cleaning slots to prevent plugging from contaminants or filter media
- No pre-oxidation is required
- Meets 2006 EPA guidelines for Arsenic III and V
- No regeneration chemicals or salts required
- Fill funnel shipped as part of filter system
- Utilizes a natural colored industry standard media tank
- Installation & operation manual included

ASB High Flow Arsenic Reduction System

NEW Purchase 3-3 water treatment systems per order and receive a 10% discount per unit. Buy 7 + water treatment systems per order and receive a 15% discount per unit.

| Product Type | Model Number | Part Number/ 3M ID | Media Cu. Ft. | Media Incl. | Flow Rate * (gpm/lpm) | Space Req. L x W x H (approx.) | Case Lot | Case Wt.** (lbs/kg) | UPC Code | List Price |
|--------------------------------|--------------|-------------------------|------------------|-------------|--------------------------|-----------------------------------|----------|------------------------|----------------|----------------------|
| Arsenic Reduction System Valve | ASB1001 | ASB1001/ 70020111004 | 1 | TO | 5/18.9 | 10" x 10" x 44" | 1 | 93/42.2 | 00016145066474 | \$3,769.80 ea |
| | ASB2001 | ASB2001/ 70020111012 | 2 | TO | 10/37.9 | 12" x 12" x 54" | 1 | 148/67.1 | 00016145066481 | \$6,411.75 ea |
| | ASB3001 | ASB3001/ 70020111020 | 3 | TO | 15/56.8 | 14" x 14" x 65" | 1 | 205/93.0 | 00016145066498 | \$9,012.50 ea |

* Calculated @ 1.5 minutes EBCT ** Approximate
TO = Titanium Oxide

Tannin Reduction Systems



CWST High Flow Series

- Smart electronics with coin style lithium ion battery backup — monitors water consumption and automatically adjusts to changing water usage
- Safety brine valve included to prevent brine tank overflow
- Fully ported four way bypass valve with durable connection fittings
- Multi-tiered salt shelf allows for use of most water softener salt
- Units contains equal amounts of both Hi capacity cation and Acrylic anion resin
- Choice of either natural or black colored media tanks
- Installation & operation manual included

CWST High Flow Series

NEW Purchase 3-3 water treatment systems per order and receive a 10% discount per unit. Buy 7 + water treatment systems per order and receive a 15% discount per unit.

| Product Type | Model Number | Part Number/ 3M ID | Media Cu. Ft. | Media Incl. | Flow Rate (gpm/lpm) | Space Req. L x W x H (approx.) | Case Lot | Case Wt. (lbs/kg) | UPC Code | List Price |
|------------------------|--------------|---------------------------|------------------|----------------|------------------------|-----------------------------------|----------|----------------------|----------------|----------------------|
| Tannin Reduction Valve | CWST200ME | CWST200ME/ 70020182674 | 2 | AA/ H Resin | 13.5/51.1 | 15" x 35" x 63" | 1 | 154/69.9 | 00016145177132 | \$3,369.28 ea |
| | CWST300ME | CWST300ME/ 70020182682 | 3 | AA/ H Resin | 18.5/70.0 | 18" x 42" x 74" | 1 | 244/110.7 | 00016145177149 | \$4,924.91 ea |

Acrylic Anion & HI -Cap Resin

Sulfur Reduction Systems



CSX High Flow Series

- Smart electronics with coin style lithium ion battery backup
- System uses a unique solution to convert Hydrogen Sulfide Gas to a filterable solid
- Efficient feed pump and solution tank shipped with filter unit
- Fully ported four way bypass valve with durable connection fittings
- Preassembled injector assembly shipped with filter system for easy connection of feed pump to water system
- Control valve pre-programmed for efficient water conserving regeneration cycles
- Includes high quality quartz filter gravel underbed to:
 - support filter media
 - reduce pressure differential through filter unit at peak flow rates
 - provide even backwash through the diameter of the media tank during regeneration
- High flow distributor with self cleaning slots to prevent plugging from contaminants or filter media
- Fill funnel shipped as part of filter system
- Installation & operation manual included

CSX High Flow Series

NEW Purchase 3-6 water treatment systems per order and receive a 10% discount per unit. Buy 7 + water treatment systems per order and receive a 15% discount per unit.

| Product Type | Model Number | Part Number/ 3M ID | Media Cu. Ft. | Media Incl. | Flow Rate (gpm/lpm) | Space Req. L x W x H (approx.) | Case Lot | Case Wt. (lbs/kg) | UPC Code | List Price |
|-----------------------------|--------------|------------------------|------------------|-------------|------------------------|-----------------------------------|----------|----------------------|----------------|----------------------|
| Electronic Time Clock Valve | CSX100 | CSX100/ 70020234699 | 1 | SX | 6/22.7 | 10" x 10" x 52" | 1 | 123/55.8 | 00016145215889 | \$3,414.45 ea |
| | CSX200 | CSX200/ 70020234707 | 2 | SX | 7/26.5 | 12" x 12" x 61" | 1 | 225/102.1 | 00016145215896 | \$3,599.85 ea |

SX = Sulfur reduction media

Backwash Filter Systems



CBF Series

- Smart electronics with coin style lithium ion battery backup
- Fully ported four way bypass valve with durable connection fittings
- Control valve pre-programmed for efficient water conserving regeneration cycles
- Filter systems shipped without filter media to allow for flexible inventory
- Includes high quality quartz filter gravel underbed to:
 - support filter media
 - reduce pressure differential through filter unit at peak flow rates
 - provide even backwash through the diameter of the media tank during regeneration
- High flow distributor with self cleaning slots to prevent plugging from contaminants or filter media
- Fill funnel shipped as part of filter system
- Installation & operation manual included

CBF Backwash Filters

NEW Purchase 3-5 water treatment systems per order and receive a 10% discount per unit. Buy 7+ water treatment systems per order and receive a 15% discount per unit.

| Product Type | Model Number | Part Number/ 3M ID | Media Cu. Ft. | Media Incl. | Flow Rate Service (gpm/lpm) | Flow Rate Backwash (gpm/lpm) | Space Req. L x W x H (approx.) | Case Lot | Case Wt. (lbs/kg) | UPC Code | List Price |
|---|-----------------|--------------------------|------------------|-------------|-----------------------------------|------------------------------------|--------------------------------------|----------|----------------------|----------------|----------------------|
| Electronic Time Clock Backwash Valve | CBF100 | CBF100/ 70020177443 | 1 | No | 3/11.4 | 5.3/20.1 | 10" x 16" x 53" | 1 | 53/24 | 00016145171963 | \$1,405.28 ea |
| | CBF100DM | CBF100DM/ 70020303718 | 1 | No | 3/11.4 | 5.3/20.1 | 10" x 16" x 53" | 1 | 53/24 | 00054007971535 | \$1,530.32 ea |
| | CBF150 | CBF150/ 70020177450 | 1.5 | No | 3/11.4 | 5.3/20.1 | 10" x 16" x 63" | 1 | 59/26.8 | 00016145171970 | \$1,575.23 ea |
| | CBF150DM | CBF150DM/ 70020303726 | 1.5 | No | 3/11.4 | 5.3/20.1 | 10" x 16" x 63" | 1 | 59/26.8 | 00054007971542 | \$1,707.11 ea |
| | CBF200 | CBF200/ 70020177468 | 2 | No | 4/15.1 | 7.3/27.6 | 12" x 16" x 63" | 1 | 62/28.1 | 00016145171987 | \$1,590.68 ea |
| | CBF200DM | CBF200DM/ 70020303734 | 2 | No | 4/15.1 | 7.3/27.6 | 12" x 16" x 63" | 1 | 62/28.1 | 00054007971559 | \$1,775.90 ea |



= Shipped within 3 days of order placement



CBW Series

- AB 1953 certified brass valve with time proven performance history
- Bypass valve supplied with 1" NPT connections
- Timer assembly capable of multiple backwashing cycles if needed
- Regeneration programming is fully adjustable conserving on water during regeneration
- Models available in both natural and black colored media tanks
- Includes high quality quartz filter gravel underbed to:
 - support filter media
 - reduce pressure differential through filter unit at peak flow rates
 - provide even backwash through the diameter of the media tank during regeneration
- High flow distributor with self cleaning slots to prevent plugging from contaminants or filter media
- Filter media shipped separately - allows for flexible inventory
- Fill funnel shipped as part of filter system
- Installation & operation manual included
- New Dome Hole versions designed for easier media replacement

CBW Backwash Filters

NEW Purchase 3-6 water treatment systems per order and receive a 10% discount per unit. Buy 7+ water treatment systems per order and receive a 15% discount per unit.

| Product Type | Model Number | Part Number/ 3M ID | Media Cu. Ft. | Media Incl. | Flow Rate Service (gpm/lpm) | Flow Rate Backwash (gpm/lpm) | Space Req. L x W x H (approx.) | Case Lot | Case Wt. (lbs/kg) | UPC Code | List Price |
|--|-------------------------|---------------------------|------------------|-------------|-----------------------------------|------------------------------------|-----------------------------------|----------|----------------------|----------------------|----------------------|
| AB 1953 Certified Brass Valve Time Clock CEC1000 | CBW1001 | CBW1001/ 70020092832 | 1 | No | 5/18.9 | 5/18.9 | 12" x 18" x 56" | 1 | 62/28.1 | 0005400797153-5 | \$2,075.45 ea |
| | CBW1001DM | CBW1001DM/ 70020303742 | 1 | No | 5/18.9 | 5/18.9 | 12" x 18" x 56" | 1 | 62/28.1 | 0005400797156-6 | \$2,324.25 ea |
| | CBW1001J | CBW1001J/ 70020261148 | 1 | No | 5/18.9 | 5/18.9 | 12" x 18" x 56" | 1 | 62/28.1 | 00016145244193 | \$2,111.50 ea |
| | CBW1501 | CBW1501/ 70020092873 | 1.5 | No | 6/22.7 | 5/18.9 | 12" x 18" x 66" | 1 | 68/30.8 | 00016145053573 | \$2,245.40 ea |
| | CBW1501DM | CBW1501DM/ 70020303759 | 1.5 | No | 6/22.7 | 5/18.9 | 12" x 18" x 66" | 1 | 68/30.8 | 00054007971573 | \$2,411.02 ea |
| | CBW1501J | CBW1501J/ 70020261155 | 1.5 | No | 6/22.7 | 5/18.9 | 12" x 18" x 66" | 1 | 68/30.8 | 00016145244209 | \$2,281.45 ea |
| | CBW2001 | CBW2001/ 70020092923 | 2 | No | 7/26.5 | 7/26.5 | 12" x 18" x 66" | 1 | 71/32.2 | 00016145053627 | \$2,260.85 ea |
| | CBW2001DM | CBW2001DM/ 70020303775 | 2 | No | 7/26.5 | 7/26.5 | 12" x 18" x 66" | 1 | 71/32.2 | 00016145053627 | \$2,479.73 ea |
| | CBW2001J | CBW2001J/ 70020092956 | 2 | No | 7/26.5 | 7/26.5 | 12" x 18" x 66" | 1 | 71/32.2 | 00054007971597 | \$2,296.90 ea |
| CBW3001 | CBW3001/ 70020092964 | 3 | No | 9/34.1 | 9/34.1 | 12" x 18" x 75" | 1 | 85/38.6 | 00016145053665 | \$3,063.08 ea | |

Non-Backwash Carbon Filter Systems



MF Series

- Easy accessible fill port opening with an upper screen to retain filter media
- Includes high quality quartz filter gravel underbed to:
 - support filter media
 - reduce pressure differential through filter unit at peak flow rates
 - provide even backwash through the diameter of the media tank during regeneration
- High flow distributor with self cleaning slots to prevent plugging from contaminants or filter media
- Fully ported four way bypass valve with durable connection fittings
- Shipped with high quality coconut shell carbon meeting CA arsenic level requirements
- Installation & operation manual included
- Fill funnel shipped as part of filter system

MF Non-Backwash Carbon Filter Series



Purchase 3-3 water treatment systems per order and receive a 10% discount per unit.
Buy 7 + water treatment systems per order and receive a 15% discount per unit.

| Product Type | Model Number | Part Number/ 3M ID | Media Cu. Ft. | Media Incl. | Flow Rate * (gpm/lpm) | Space Req. L x W (approx.) | Case Lot | Case Wt.** (lbs/kg) | UPC Code | List Price |
|-------------------------------|--------------|-------------------------|------------------|-------------|--------------------------|-------------------------------|----------|------------------------|----------------|---------------|
| Non-Backwashing Carbon Filter | MF0844A | MF0844A/ 70020097823 | 1 | A | 5.2/19.7 | 8" x 44" | 1 | 60 | 00016145058318 | \$1,107.25 ea |
| | MF1044A | MF1044A/ 70020097831 | 2 | A | 8.2/31.0 | 10" x 44" | 1 | 89 | 00016145058325 | \$1,236.00 ea |
| | MF1354A | MF1354A/ 70020097856 | 3 | A | 13.8/52.2 | 13" x 54" | 1 | 97 | 00016145058349 | \$1,570.75 ea |

* Calculated at 15 gpm service flow

A = Activated Carbon

Iron Reduction Systems



APIF Series – Iron Reduction Filter Systems

Features:

- No chemicals, chlorine, salt or potassium permanganate needed!
- Automatically adjusts pH of acid water for reduced corrosion
- Smart electronics with coin style lithium ion battery backup
- Control valve pre-programmed for efficient water conserving regeneration cycles
- Includes high quality quartz filter gravel underbed to:
 - support filter media
 - reduce pressure differential through filter unit at peak flow rates
 - provides backwash through the diameter of the media tank during regeneration
- High flow distributor with self cleaning slots to help prevent plugging from contaminants or filter media
- Systems shipped with fully adjustable hydro charger for complete oxidation of metals for reliable filtration
- Blended filter media provided is a homogenous mixture to support even pH adjustment and filtration
 - choice of two media bed types to address specific water needs (consult customer service for selection)
- Better tasting drinking water
- Reduces rotten-egg odors (hydrogen sulfide gas)
- Reduces rust stains in laundry and plumbing fixtures
- Installation & operation manual included

APIF High Flow Series



Purchase 3-6 water treatment systems per order and receive a 10% discount per unit.
Buy 7 + water treatment systems per order and receive a 15% discount per unit.

| Product Type | Model Number | Part Number/ 3M ID | Media Cu. Ft. | Media Incl. | Flow Rate (gpm/lpm) | Space Req. L x W x H (approx.) | Case Lot | Case Wt. (lbs/kg) | UPC Code | List Price |
|---|------------------------------------|------------------------------|------------------|-------------|------------------------|-----------------------------------|----------|----------------------|----------------|----------------------|
| Iron Reduction Electronic Time Clock Valve | APIF100DM | APIF100DM/ 70020303270 | 1.0 | MC | 6/22.7 | 10" x 16" x 53" | 1 | 143/64.9 | 00054007971108 | \$1,785.20 ea |
| | APIF150DM | APIF150DM/ 70020303585 | 1.5 | MC | 7/26.5 | 10" x 16" x 63" | 1 | 186/84.4 | 00016145154355 | \$1,964.75 ea |
| | APIF200DM | APIF200DM/ 70020303627 | 2.0 | MC | 9/34.1 | 12" x 16" x 63" | 1 | 257/116.6 | 00054007971443 | \$2,087.81 ea |
| | APIF300 | APIF300/ 70020159730 | 3.0 | MC | 12/45.4 | 14" x 16" x 74" | 1 | 353/160.1 | 00016145154379 | \$2,682.66 ea |
| | APIF100J | APIF100J/ 70020241173 | 1.0 | MC | 6/22.7 | 10" x 16" x 53" | 1 | 143/64.9 | 00016145225345 | \$1,693.86 ea |
| | APIF150J | APIF150J/ 70020241181 | 1.5 | MC | 7/26.5 | 10" x 16" x 63" | 1 | 186/84.4 | 00016145225352 | \$1,863.81 ea |
| | APIF200J | APIF200J/ 70020241199 | 2.0 | MC | 9/34.1 | 12" x 16" x 63" | 1 | 257/116.6 | 00016145225369 | \$2,038.91 ea |
| | APIF300J | APIF300J/ 70020241207 | 3.0 | MC | 12/45.4 | 14" x 16" x 74" | 1 | 353/160.1 | 00016145225376 | \$2,821.71 ea |
| | APIF100PT incl. Aeration Tank | APIF100PT/ 70020231679 | 1.0 | MC | 6/22.7 | 10" x 16" x 53" | 1 | 143/64.9 | 00016145213908 | \$2,425.16 ea |
| | APIF150PT incl. Aeration Tank | APIF150PT/ 70020231695 | 1.5 | MC | 7/26.5 | 10" x 16" x 63" | 1 | 186/84.4 | 00016145213922 | \$2,595.11 ea |
| | APIF200PT incl. Aeration Tank | APIF200PT/ 70020231711 | 2.0 | MC | 9/34.1 | 12" x 16" x 63" | 1 | 257/116.6 | 00016145213946 | \$2,759.91 ea |
| | APIF300PT incl. Aeration Tank | APIF300PT/ 70020231737 | 3.0 | MC | 12/45.4 | 14" x 16" x 74" | 1 | 353/160.1 | 00016145213960 | \$3,455.16 ea |
| | APIF100MDM | APIF100MDM/ 70020303551 | 1.0 | MC-M | 6/22.7 | 10" x 16" x 53" | 1 | 143/64.9 | 00016145173417 | \$1,833.47 ea |
| | APIF150MDM | APIF150MDM/ 70020303593 | 1.5 | MC-M | 7/26.5 | 10" x 16" x 63" | 1 | 186/84.4 | 00054007971412 | \$2,021.91 ea |
| | APIF200M | APIF200M/ 70020178938 | 2.0 | MC-M | 9/34.1 | 12" x 16" x 63" | 1 | 257/116.6 | 00016145173431 | \$2,080.11 ea |
| | APIF300M | APIF300M/ 70020178946 | 3.0 | MC-M | 12/45.4 | 14" x 16" x 74" | 1 | 353/160.1 | 00016145173448 | \$2,821.71 ea |
| | APIF100MJ | APIF100MJ/ 70020141215 | 1.0 | MC-M | 6/22.7 | 10" x 16" x 53" | 1 | 143/64.9 | 00016145225406 | \$1,740.21 ea |
| | APIF150MJ | APIF150MJ/ 70020241223 | 1.5 | MC-M | 7/26.5 | 10" x 16" x 63" | 1 | 186/84.4 | 00016145225413 | \$1,933.33 ea |
| | APIF200MJ | APIF200MJ/ 70020241231 | 2.0 | MC-M | 9/34.1 | 12" x 16" x 63" | 1 | 257/116.6 | 00016145225420 | \$2,131.61 ea |
| | APIF300MJ | APIF300MJ/ 70020241249 | 3.0 | MC-M | 12/45.4 | 14" x 16" x 74" | 1 | 353/160.1 | 00016145225437 | \$2,960.76 ea |
| | APIF100PTDM incl. Aeration Tank | APIF100PTDM/ 70020303577 | 1.0 | MC-10MP | 6/22.7 | 10" x 16" x 53" | 1 | 143/64.9 | 00054007971399 | \$2,622.31 ea |
| | APIF150MPT incl. Aeration Tank | APIF150MPT/ 70020231687 | 1.5 | MC-10MP | 7/26.5 | 10" x 16" x 63" | 1 | 186/84.4 | 00016145213915 | \$2,664.63 ea |
| | APIF200PTDM incl. Aeration Tank | APIF200PTDM/ 70020303650 | 2.0 | MC-10MP | 9/34.1 | 12" x 16" x 63" | 1 | 257/116.6 | 00054007971474 | \$2,972.99 ea |
| | APIF300MPT incl. Aeration Tank | APIF300MPT/ 70020231729 | 3.0 | MC-10MP | 12/45.4 | 14" x 16" x 74" | 1 | 353/160.1 | 00016145213953 | \$3,594.21 ea |
| | APIF100MPTDM | APIF100MPTDM/ 70020303577 | 1.0 | MC-10MP | 6/22.7 | 10"X16"X53" | 1 | 143/64.9 | 00054007971382 | \$2,574.04 ea |
| | APIF150MPTDM | APIF150MPTDM/ 70020303577 | 1.5 | MC-10MP | 7/26.5 | 10"X16"X63" | 1 | 186/84.4 | 00054007971429 | \$2,753.62 ea |

MC = Standard Iron Filter Media, MC-M = M-BED Media, Media is included and shipped with the product, but is not loaded



= Shipped within 3 days of order placement



APPM Series

Features:

- Smart electronics with coin style lithium ion battery backup
- Fully ported four way bypass valve with durable connection fittings
- Control valve pre-programmed for efficient water conserving regeneration cycles
- Includes high quality quartz filter gravel underbed to:
 - support filter media
 - reduce pressure differential through filter unit at peak flow rates
 - provides even backwash through the diameter of the media tank during regeneration
- High flow distributor with self cleaning slots to prevent plugging from contaminants or filter media
- Blended filter media provides is a homogenous mixture for even pH adjustment and filtration
 - choice of two media beds type to address specific water needs
- Includes an oil less air pump to provide an air source for metal oxidation
- Includes MAXAPRT air release valve to maintain proper air level with in pressure vessel and 1" plumbing connections
- Installation & operation manual included

APPM High Flow Series (includes MAXAPRT air pump & release tank assembly)



Purchase 3-5 water treatment systems per order and receive a 10% discount per unit. Buy 7+ water treatment systems per order and receive a 15% discount per unit.

| Product Type | Model Number | Part Number/ 3M ID | Media Cu. Ft. | Media Incl. | Flow Rate (gpm/lpm) | Space Req. L x W x H (approx.) | Case Lot | Case Wt. (lbs/kg) | UPC Code | List Price |
|-----------------------------------|--------------|----------------------------|------------------|-------------|------------------------|-----------------------------------|----------|----------------------|----------------|---------------|
| Electronic Time Clock Valve | APPM100DM | APPM100DM/ 70020303668 | 1.0 | MC* | 6/22.7 | 10" x 16" x 53" | 1 | 143/64.9 | 00054007971481 | \$3,797.87 ea |
| | APPM150DM | APPM150DM/ 70020303684 | 1.5 | MC* | 7/26.5 | 10" x 16" x 63" | 1 | 186/84.4 | 00054007971504 | \$3,977.42 ea |
| | APPM200DM | APPM200DM/ 70020303700 | 2.0 | MC* | 9/34.1 | 12" x 16" x 63" | 1 | 257/116.6 | 00054007971528 | \$4,183.75 ea |
| | APPM100MDM | APPM100MDM/ 70020303676 | 1.0 | MC-M | 6/22.7 | 10" x 16" x 53" | 1 | 143/64.9 | 00054007971498 | \$3,708.86 ea |
| | APPM150MDM | APPM150MDM/ 70020303692 | 1.5 | MC-M | 7/26.5 | 10" x 16" x 63" | 1 | 186/84.4 | 00054007971511 | \$4,049.82 ea |
| | APPM200MDM | APPM200M/ 70020303767 | 2.0 | MC-M | 9/34.1 | 12" x 16" x 63" | 1 | 257/116.6 | 00054007971580 | \$4,293.26 ea |

* Media is included and shipped with the product, but is not loaded. Space Req. height does not incl. MAXAPRT

MC = Standard Iron Filter Media, MC-M = M-BED Media



MCA Series

Features:

- AB 1953 certified brass valve with time proven performance history (CEC 1000)
- Bypass valve supplied with 1" NPT connections
- Regeneration programming is fully adjustable conserving on water during regeneration
- Installation & operation manual included
- Models available in both natural and black colored media tanks
- Includes high quality quartz filter gravel underbed to:
 - support filter media
 - reduce pressure differential through filter unit at peak flow rates
 - provides even backwash through the diameter of the media tank during regeneration
- High flow distributor with self cleaning slots to help reduce plugging from contaminants or filter media
- Fill funnel shipped as part of filter system

High Flow CEC1000 Series



Purchase 3-6 water treatment systems per order and receive a 10% discount per unit. Buy 7+ water treatment systems per order and receive a 15% discount per unit.

| Product Type | Model Number | Part Number/ 3M ID | Media Cu. Ft. | Media Incl. | Flow Rate (gpm/lpm) | Space Req. L x W x H (approx.) | Case Lot | Case Wt. (lbs/kg) | UPC Code | List Price |
|--|--------------|---------------------------|------------------|-------------|------------------------|-----------------------------------|----------|----------------------|----------------|---------------|
| AB 1953 Certified Brass Valve Time Clock CEC1000 | MCA1001 | MCA1001/ 70020097195 | 1.0 | MC | 5/18.9 | 12" x 18" x 52" | 1 | 157/71.2 | 00016145057687 | \$2,240.25 ea |
| | MCA1001J | MCA1001J/ 70020097278 | 1.0 | MC | 5/18.9 | 12" x 18" x 52" | 1 | 157/71.2 | 00016145057762 | \$2,276.30 ea |
| | MCA1001M | MCA1001M/ 70020097302 | 1.0 | MC-M | 5/18.9 | 12" x 18" x 52" | 1 | 157/71.2 | 00016145057793 | \$2,348.40 ea |
| | MCA1001MJ | MCA1001MJ/ 70020261163 | 1.0 | MC-M | 5/18.9 | 12" x 18" x 52" | 1 | 157/71.2 | 00016145244216 | \$2,384.45 ea |
| | MCA1501 | MCA1501/ 70020097401 | 1.5 | MC | 7/26.5 | 12" x 18" x 62" | 1 | 193/87.5 | 00016145057892 | \$2,410.20 ea |
| | MCA1501J | MCA1501J/ 70020097427 | 1.5 | MC | 7/26.5 | 12" x 18" x 62" | 1 | 193/87.5 | 00016145057915 | \$2,446.25 ea |
| | MCA1501M | MCA1501M/ 70020097435 | 1.5 | MC-M | 7/26.5 | 12" x 18" x 62" | 1 | 193/87.5 | 00016145057922 | \$2,518.35 ea |
| | MCA1501MJ | MCA1501MJ/ 70020261171 | 1.5 | MC-M | 7/26.5 | 12" x 18" x 62" | 1 | 193/87.5 | 00016145244223 | \$2,554.40 ea |
| | MCA2001 | MCA2001/ 70020097476 | 2.0 | MC | 8/30.2 | 12" x 18" x 62" | 1 | 264/119.8 | 00016145057960 | \$2,425.65 ea |
| | MCA2001J | MCA2001J/ 70020097534 | 2.0 | MC | 8/30.2 | 12" x 18" x 62" | 1 | 264/119.8 | 00016145058028 | \$2,461.70 ea |
| | MCA2001M | MCA2001M/ 70020097559 | 2.0 | MC-M | 8/30.2 | 12" x 18" x 62" | 1 | 264/119.8 | 00016145058042 | \$2,533.80 ea |
| | MCA2001MJ | MCA2001MJ/ 70020261189 | 2.0 | MC-M | 8/30.2 | 12" x 18" x 62" | 1 | 264/119.8 | 00016145244230 | \$2,569.85 ea |

* Media is included and shipped with the product, but is not loaded. A funnel for loading is provided. Space Req. height does not incl. MAXAPRT

MC= Standard Iron Filter Media, MC-M = M-BED Media

Acid Neutralizer Systems



APUN Series — Acid Neutralizer

Features:

- Easy accessible fill port opening with an upper screen to retain filter media
- Includes high quality quartz filter gravel underbed to:
 - support filter media
 - reduce pressure differential through filter unit at peak flow rates
- High flow distributor with self cleaning slots to help prevent plugging from contaminants or filter media
- Fully ported four way bypass valve with durable connection fittings
- Available with media as part of system or less media for custom blending of filter media
- Systems shipped with connections to accept boiler drain to aid in flushing media to waste prior to use
- 1" NPT inlet/outlet
- Installation & operation manual included
- Fill funnel shipped as part of filter system

APUN Acid Neutralizers

NEW Purchase 3-3 water treatment systems per order and receive a 10% discount per unit. Buy 7 + water treatment systems per order and receive a 15% discount per unit.

| Product Type | Model Number | Part Number/ 3M ID | Media Cu. Ft. | Media Incl. | Flow Rate (gpm/lpm) | Space Req. L x W x H (approx.) | Case Lot | Case Wt. (lbs/kg) | UPC Code | List Price |
|---------------------------|--------------|----------------------------|------------------|-------------|------------------------|-----------------------------------|----------|----------------------|----------------|----------------------|
| Acid Neutr. Up-Flow | APUN101 | APUN101/ 70020092295 | 1 | C | 6/22.7 | 10" x 10" x 52" | 1 | 123/55.8 | 00016145053061 | \$1,066.05 ea |
| | APUN201 | APUN201/ 70020092303 | 2 | C | 7/26.5 | 12" x 12" x 61" | 1 | 225/102.1 | 00016145053078 | \$1,416.74 ea |
| | APUN301 | APUN301/ 70020047380 | 3 | C | 12/45.4 | 14" x 14" x 65" | 1 | 398/180.5 | 00016145020636 | \$2,187.72 ea |
| | APUN100-LM | APUN100-LM/ 70020164391 | 1 | N/A | 6/22.7 | 10" x 10" x 52" | 1 | 84/38.1 | 00016145158971 | \$901.79 ea |
| | APUN200-LM | APUN200-LM/ 70020164409 | 2 | N/A | 7/26.5 | 12" x 12" x 61" | 1 | 92/41.7 | 00016145158988 | \$1,210.25 ea |

C = Calcium Carbonate



= Shipped within 3 days of order placement

Metering Pumps/Solution Tanks



Metering Pumps/Solution Tanks/Chemical Feed Pumps

For hydrogen sulfide, acid water, bacteria, tannins, algae, iron and manganese water quality concerns

- Versatile pump rates
- Designed for easy installation and operation — low maintenance
- Durable pump housing — resistant to corrosion
- For use with various water treatment solutions
- Rugged construction

Specifications:

- Feed Rates: 3–24 gal/day (11–91 liter/day)
- Maximum Operating Pressure: 100 psi (690 kPa)

| Application | Suggested Dosing of Chlorine | Other | Treatment Solution |
|------------------|--|------------|--------------------|
| Bacteria | 1 ppm residual test reading after holding tank | Acid Water | Soda Ash |
| Hydrogen Sulfide | 3 ppm for each part of hydrogen sulfide | | |
| Iron | 1 ppm for each part of iron | | |

Note: Injecting chlorine solution into system causes dissolved iron, manganese and hydrogen sulfide to precipitate for reduction downstream with an Aqua-Pure® backwashing system.

Metering Pumps/Solution Tanks

| Product Type | Model Number | Part Number/ 3M ID | Description | Dimensions L x W x H | Case Lot | Case Wt. (lbs/kg) | UPC Code | List Price |
|------------------|--------------|--------------------------|-----------------------------------|-------------------------|-------------|----------------------|----------------|--------------------|
| Metering Pump | APMP100 | APMP100/ 70020041391 | Metering Pump • 115 Volt/60 Hz | 3.5" x 7.5" x 8.5" | 1 | 10/4.5 | 00016145019265 | \$794.73 ea |
| | APMP100A | APMP100A/ 70020041409 | Metering Pump • 230 Volt/60 Hz | 3.5" x 7.5" x 8.5" | 1 | 10/4.5 | 00016145019272 | \$844.81 ea |
| Solution Tank | APSLTANK | APSLTANK/ 70020101021 | 15 Gallon Solution Tank | 14"d x 24"h | 1 | 7/3.2 | 00016145020612 | \$233.12 ea |

Water Treatment Accessories

| Model Number | Part Number/ 3M ID | Description | Case Lot | Case Wt. (lbs/kg) | UPC Code | List Price |
|--------------------|---------------------------|---|--------------------|----------------------|----------------|--------------------|
| Water Cover | V3175WC-A/ 70020159540 | Almond Only (For CWS Series) | Contact Factory | Contact Factory | 00016145154188 | \$43.71 ea |
| APH-2 | APH-2/ 70020047356 | Air Release Valve D495 | 1 | 1/0.5 | 00016145020605 | \$116.18 ea |
| 62316-31 | 62316-31 | Black Jacket for use with Tank Size 8" x 44" | 1 | N/A | 00016145235573 | \$27.50 ea |
| 62316-32 | 62316-32 | Black Jacket for use with Tank Size 10" x 44" | 1 | N/A | 00016145235740 | \$28.71 ea |
| 62316-33 | 62316-33 | Black Jacket for use with Tank Size 10" x 54" | 1 | N/A | 00016145235580 | \$36.05 ea |
| 6238731 | 6238731/ 70020295229 | Black Jacket for use with Tank Size 10" x 54" | 1 | N/A | 00016145235580 | \$36.08 ea |
| 62316-34 | 62316-34 | Black Jacket for use with Tank Size 12" x 54" | 1 | N/A | 00016145235757 | \$75.16 ea |
| 62316-35 | 62316-35 | Black Jacket for use with Tank Size 14" x 65" | 1 | N/A | 00016145235764 | \$96.23 ea |
| 6238731 | 6238731/ 70020295229 | Dome Hole Tank Funnel | 1 | N/A | 0054007964858 | \$67.01 ea |
| 6231637 | 6231637/ 70020284454 | Formerly T40CR0844P Chrome Jacket for use with Tank Size 8" x 44" | 1 | N/A | 00016145266690 | \$76.38 ea |
| 6231638 | 6231638/ 70020286822 | Formerly T40CR1044P Chrome Jacket for use with Tank Size 10" x 44" | 1 | N/A | 00016145268656 | \$76.38 ea |
| 6231639 | 6231639/ 70020286830 | Formerly T40CR1054P Chrome Jacket for use with Tank Size 10" x 54" | 1 | N/A | 00016145268663 | \$91.65 ea |
| 6231642 | 6231642/ 70020286855 | Formerly T40CR1254P Chrome Jacket for use with Tank Size 12" x 54" | 1 | N/A | 00016145268687 | \$141.75 ea |
| 6231641 | 6231641/ 70020286848 | Formerly T40CR1465P Chrome Jacket for use with Tank Size 14" x 65" | 1 | N/A | 00016145268670 | \$201.64 ea |
| T40BK-8 | T40BK-8/ 70020056498 | media tank Cap 8" | 1 | N/A | 00016145029424 | \$19.54 ea |
| T40BK-10 | T40BK-10/ 70020056456 | media tank Cap 10" | 1 | N/A | 00016145029387 | \$19.54 ea |
| T40BK-12 | T40BK-12/ 70020056464 | media tank Cap 12" | 1 | N/A | 00016145029394 | \$20.76 ea |
| T40BK-14 | T40BK-14/ 70020056472 | media tank Cap 14" | 1 | N/A | 00016145502940 | \$20.76 ea |
| HC10 | HC10/ 70020050970 | Plastic Hydrocharger | 1 | N/A | 00016145024115 | \$90.64 ea |
| FS1 | FS1/ 70020050830 | Flow Switch for use with ProMax/APPM Series | 1 | N/A | 00016145024009 | \$264.44 ea |
| N/A | 6238731/ 70020295229 | Fill funnel for Dome Hole Tank | 1 | N/A | 00054007964858 | \$68.49 ea |
| N/A | V3007/ 70020153956 | Adapter Kit 1" NPT Elbow | 1 | N/A | 00016145148583 | \$15.57 ea |
| N/A | V3007-02 70020120872 | Adapter Kit 1" Brass Sweat | 1 | N/A | 00016145118074 | \$28.51 ea |
| N/A | V3007-03LF 70020268853 | Adapter Kit 3/4" Low Lead | 1 | N/A | 00016145251481 | \$33.09 ea |
| N/A | V3007-04 70020138700 | Adapter Kit 1" NPT Plastic | 1 | N/A | 00016145135842 | \$20.56 ea |
| N/A | V3007-06 70020182989 | Adapter Kit 1" BSP Plastic | 1 | N/A | 00016145177446 | \$19.09 ea |
| N/A | 18706 7002061407 | Yoke, 1" Connection (For NWS, CS/CSM, CBW, MCA models) | 1 | N/A | 00016145034312 | \$17.84 ea |

Adapter Kits to be used on CWS, ASB, CWST, CSX, MF, APIF, APPM, APUN

Water Test Kits

| Model Number | Part Number/ 3M ID | Description | Case Lot | Case Wt. (lbs/kg) | UPC Code | List Price |
|-----------------|-------------------------|---|----------|----------------------|----------------|---------------------------|
| APTK1 | APTK1/ 70020092279 | Tests for iron, manganese, pH, sulfides, tannins, hardness and copper | 1 | 7/3.2 | 00016145053047 | \$1,168.72 ea |
| APTK62B | 5592131/ 70020017607 | Test Kit for iron, hardness and pH | 1 | 5/2.3 | 00016145007903 | \$766.22 ea |
| ARS-TEST | ARS-TEST 70020119684 | Test Kit for Arsenic | 1 | 1/0.5 | 00016145117039 | \$80.86 |
| AP-TEST | 5621304/ 70020197284 | <ul style="list-style-type: none"> Test Kit for 3M Purification laboratory analysis: pH, TDS, hardness, turbidity, iron, manganese, tannins and other non-health related contaminants Bulk -10 kits | 1 | 1/0.5 | 00016145185212 | \$13.50 case of 10 |

FILTER MEDIA & RESIN SELECTIONS

| Part Number/ 3M ID | Media Type | Quantity (Cu. Ft.) | Package | Weight (lbs) (approx) | UPC | List Price |
|-----------------------------------|--|-----------------------|------------------------|--------------------------|----------------|---------------|
| A-050P/ 70020092139 | ACTIVATED CARBON | 0.50 | PAIL | 14 | 00016145052910 | \$80.79 ea |
| AA-050MP/ 70020047240 | ACRYLIC ANION (TANNIN) RESIN | 0.50 | PAIL | 26 | 00016145020506 | \$518.61 ea |
| ACC-050P/ 70020047265 | ACTIVATED CARBON FOR CHLORAMINES REDUCTION | 0.50 | PAIL | 17 | 00092498003038 | \$305.00 ea |
| C-050P/ 70020092758 | CALCIUM CARBONATE | 0.50 | PAIL | 45 | 00092498003601 | \$37.67 ea |
| CSI-10/ 70020093434 | RUST BUSTER REBED KIT | 1.00 | PAIL | 88 | 00016145054105 | \$314.99 ea |
| D-050P/ 70020049790 | ANION RESIN (NITRATE) | 0.50 | PAIL | 22 | 00016145022968 | \$527.89 ea |
| F-050P/ 70020050210 | FILTER-AG® | 0.50 | PAIL | 13 | 00016145023385 | \$48.59 ea |
| FM-050P/ 70020050517 | FM = FINE MESH RESIN | 0.50 | PAIL | 26 | 00016145023682 | \$114.64 ea |
| G-050P/ 70020050997 | GREENSAND | 0.50 | PAIL | 23 | 00092498004851 | \$84.07 ea |
| H-050P 70020095439 | HCP = HI-CAP RESIN (CATION32) | 0.50 | PAIL | 43 | 00016145056031 | \$111.36 ea |
| X9000080 (IX2412)/ 70020267699 | MINERAL CLEANER & RUST REDUCER | N/A | 12 – 24 oz. bottles | 18 | 00016145250316 | \$191.06 ea |
| MC-050P/ 70020097054 | MC = IRON FILTER STANDARD MEDIA | 0.50 | PAIL | 43 | 00016145057564 | \$52.80 ea |
| MC-050MP/ 70020051929 | MC-M = IRON FILTER M-BED MEDIA | 0.50 | PAIL | 43 | 00016145025037 | \$59.48 ea |
| ML-050P/ 70020052018 | GENERAL PURPOSE, MULTI-LAYER, Particulate MEDIA | 0.50 | PAIL | 43 | 00092498003649 | \$72.77 ea |
| N-050P/ 70020097955 | NEUTRALIZER | 0.50 | PAIL | 43 | 00092498003625 | \$62.23 ea |
| PH35/ 70020100437 | SODA ASH (will ship in 2 pails) | 0.50 | PAIL | 35 | 00092498004073 | \$93.89 ea |
| pHPlus 70020100411 | MAGNESIUM OXIDE | N/A | 6 – 4 lb. bottles | 18 | 00092498003724 | \$160.68 ea |
| QC-12P/ 70020100833 | QUARTZ GRAVEL (COARSE, 1/4 x 1/8 INCHES) | 0.12 | PAIL | 12 | 00016145061042 | \$33.31 ea |
| QC-15P/ 70020141266 | | 0.15 | | 15 | 00016145138355 | \$33.85 ea |
| QC-18P/ 70020100841 | | 0.18 | | 00016145061059 | \$34.40 ea | |
| QC-20P/ 70020100858 | | 0.20 | | 20 | 00092498004066 | \$34.94 ea |
| QC-25P/ 70020100866 | | 0.25 | | 25 | 00016145061066 | \$35.75 ea |
| QC-35P/ 70020054881 | | 0.35 | | 35 | 00016145027840 | \$37.67 ea |
| QC-50P/ 70020100874 | | 0.50 | | 50 | 00092498003755 | \$38.03 ea |
| QF-20/ 70020054956 | QUARTZ GRAVEL (#16 FLINT, FINE) | 0.20 | PAIL | 20 | 00016145027918 | \$54.59 ea |
| QF-50P/ 70020054964 | 0.50 | 50 | | 00016145027925 | \$38.03 ea | |
| QFS-50P/ 70020055029 | FILTER SAND (.44 - .55 mm, EXTRA FINE) | 0.50 | PAIL | 50 | 00016145027987 | \$60.05 ea |
| QXC-50P/ 70020055136 | QUARTZ GRAVEL (1/2 x 1/4 INCHES, EXTRA COARSE) | 0.50 | PAIL | 50 | 00016145028090 | \$46.41 ea |
| SS0104/ 70020101013 | 3M™ SULFUR REDUCTION CONCENTRATED SOLUTION (4 – 1 GALLON BOTTLES) | N/A | BOTTLE | 33.2 | 00016145061141 | \$194.34 cs |
| SX-050P/ 70020101138 | SULFUR REDUCTION | 0.50 | PAIL | 90 | 00016145061172 | \$68.24 ea |
| TO-10B/ 70020120666 | TITANIUM OXIDE | 1.00 | BAG | 40 | 00016145117862 | \$1,337.46 ea |
| X-050P/ 70020102573 | MAGNESIUM OXIDE | 0.50 | PAIL | 35 | 00016145062551 | \$134.84 ea |

Repackaging of any of the above products in smaller quantities for sale at retail may be in violation of packaging and labeling requirements established by the U.S. Consumer Product Safety Commission and the Department of Transportation. The practice of repackaging is strongly discouraged because of potentially harmful health risks. 3M Purification Inc. assumes no liability whatsoever in its connection. Additionally, the above products cannot be shipped by air and may be subject to hazardous materials shipping surcharges when shipped by ground transportation.

NOTES

Replacement Parts

The Aqua-Pure® portfolio includes a full line of parts and accessories that help plumbing professionals provide customers with superior water filtration and treatment solutions.

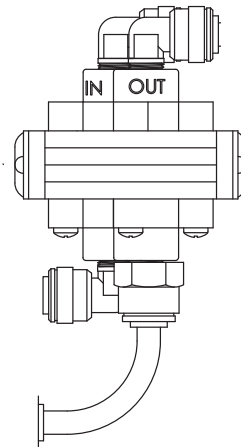
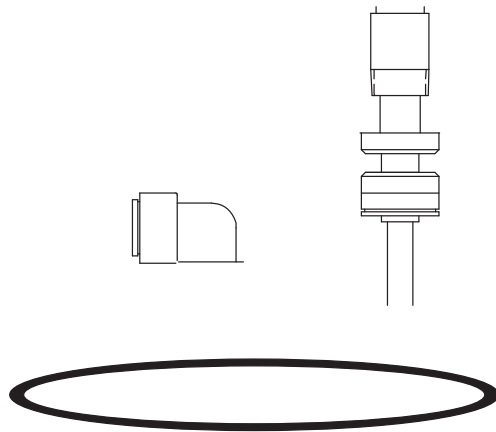
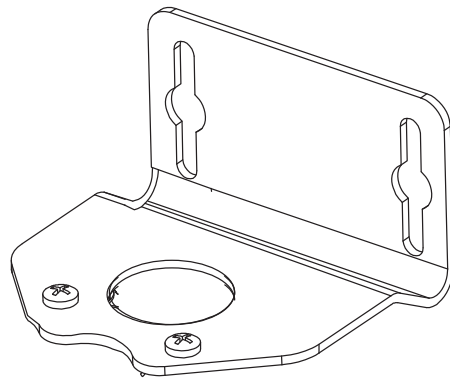
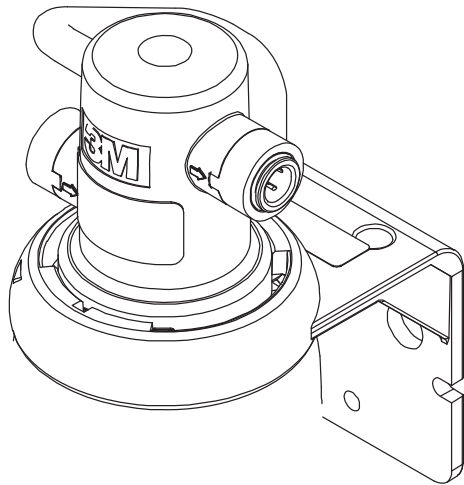

Replacement Parts Section

AP11S/AP11T/AP12S/AP12T/AP26T/AP51T/AP101S/AP101T/AP102S/AP102T/AP141T

| Item No. | Part Number/ 3M ID | Description | List Price (ea) |
|-----------|---------------------------|---|-----------------|
| 1 | 6981502/ 70020022318 | Head Assy (AP101/AP102) | \$96.93 |
| 1A | 6981401C/ 70020028521 | Head Assy (AP11/AP12/AP51/AP52) | \$64.90 |
| 1B | 6986202/ 70020022359 | Head Assy (AP25/AP26) | \$72.98 |
| 2 | 6981131C/ 70020028505 | Housing (1-high opaque) | \$56.61 |
| 3 | 6981142/ 70020022268 | Housing (1-high transparent Isoplast sump) | \$123.46 |
| 4 | 6493201C/ 70020043124 | Housing (2-high opaque) w/post | \$86.32 |
| 5 | 6981141/ 70020075092 | Housing (2-high transparent Isoplast sump) w/o post | \$173.06 |
| not shown | 6981731C/ 70020028539 | 2-high center post | \$9.35 |
| 6 | 63597174C/ 70020008242 | O-ring | \$5.31 |
| not shown | 5548001C/ 70020027135 | Gasket kit for head (AP101/AP102) | \$14.19 |
| 8 | 5548801C/ 70020027143 | Pressure relief button kit | \$12.30 |
| not shown | 6980931/ 70020022243 | Shaft | \$3.13 |
| not shown | 6981031/ 70020022250 | Handle (AP101/AP102 head assy.) | \$12.94 |
| 11 | 6843432C/ 70020028430 | Wrench | \$8.89 |
| 12 | — | Cartridge — refer to cartridge section | |
| not shown | 6983831/ 70020022334 | Spool (AP101/AP102) | \$3.11 |
| not shown | 6981231/ 70020022276 | Rotary Valve (AP101/AP102) | \$5.68 |

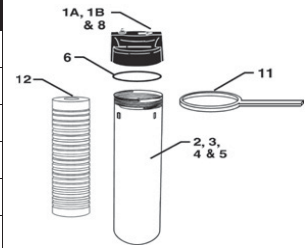

AP10S/AP10T/AP50T/AP100/AP100T/AP150/AP150T

| Item No. | Part Number/ 3M ID | Description | List Price (ea) |
|----------|--------------------------|---|-----------------|
| 2 | 3703122C/ 70020024694 | O-ring for post assembly | \$4.02 |
| 4 | 5548801C/ 70020027143 | Pressure relief button kit | \$12.30 |
| 5 | — | Cartridge — refer to cartridge section | |

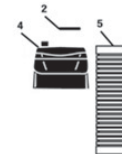

AP10/AP50

| Item No. | Part Number/ 3M ID | Description | List Price (ea) |
|----------|--------------------------|---|-----------------|
| 1 | 3685135/ 70020014190 | Gasket for sump | \$5.30 |
| 2 | — | Cartridge — refer to cartridge section | |
| 3 | 3424532/ 70020126119 | Seal plate | \$6.27 |
| 4 | 6939301/ 70020022078 | Wrench | \$19.53 |
| 5 | 5548801C/ 70020027143 | Pressure relief button kit | \$12.30 |

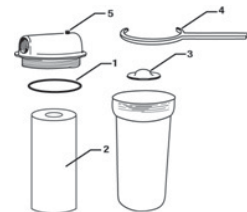

AP801/AP801-1.5/AP802/AP802-1.5

| Item No. | Part Number/ 3M ID | Description | List Price (ea) |
|----------|-------------------------|---|-----------------|
| 1 | 6200901/ 70020020825 | Head — 1" NPT Connection | \$58.05 |
| 1 | 6200902/ 70020020833 | Head — 1-1/2" NPT Connection | \$61.43 |
| 2 | — | Cartridge — refer to cartridge section | |
| 3 | 6889832/ 70020021906 | Gasket (without logo — new style) | \$3.42 |
| 4 | 6201035/ 70020020866 | Sump for AP801T/AP801T-1.5 | \$145.32 |
| 4 | 6201031/ 70020020841 | Sump for AP801/AP801-1.5 | \$75.23 |
| 4 | 6201032/ 70020020858 | Sump for AP802/AP802-1.5 | \$98.80 |
| 5 | 6889932/ 70020021914 | Pressure relief button kit | \$6.62 |
| 6 | 6890033/ 70020021930 | Wrench | \$10.54 |
| 7 | 6890131/ 70020021948 | Mounting kit (optional) | \$30.79 |



AP400/AP1610/AP2610/SS1/SS1HA/SS1H1/SS2HA/SS2HB/SSTSD

| Item No. | Part Number/ 3M ID | Description | List Price (ea) |
|----------|---------------------------|--|-----------------|
| 1 | 35581-01C/ 70020024629 | Mounting bracket — for all metal filters | \$10.85 |
| 2 | 6207632/ 70020021070 | SS Head-3/4" NPT for AP400/AP1610/AP2610/SS1HA | \$104.81 |
| 2A | 6207531/ 70020021054 | SS Head-3/8" NPT vertical for SS1/SS2 | \$100.65 |
| 3 | 3473713C/ 70020024538 | Gasket for all metal filters | \$5.90 |
| 4 | 6357102C/ 7002016558 | Centering guide for AP2610/SS2 | \$45.32 |
| 5 | 6446202C/ 70020027960 | Housing for AP2610/SS2/SST2 Series | \$512.27 |
| 5A | 6362604C/ 70020027952 | Housing for AP1610/AP1610SS/SSTSD/ SS1/SST Series | \$204.41 |
| 6 | 6207831/ 70020007343 | SS Ring nut for metal filters | \$46.73 |
| 7 | 6356201C/ 70020027937 | Wrench for all metal filters | \$5.90 |
| 8 | 6207532/ 70020021062 | Head for SSTSD | \$103.57 |
| 9 | 6207731/ 70020144245 | Head — 1" horizontal for SST2HB | \$124.38 |
| 10 | 6207632/ 70020021070 | Head — 3/4" horizontal for SST1HA | \$104.81 |
| 11 | 6207831/ 70020007343 | Nickel plated ring nut for SST1 | \$46.73 |

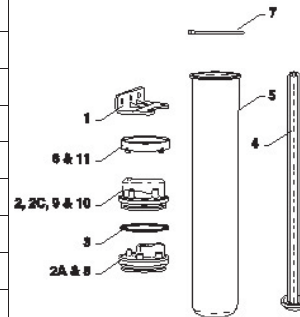

AP Easy

| Item No. | Part Number/ 3M ID | Description | List Price (ea) |
|-----------|---------------------------|--|-----------------|
| 1 | 52-196106/ 70020042902 | Head & Bracket Assy. For DWS & Cooler Series | \$47.91 |
| not shown | 50-4011/ 700200243278 | Install Kit For DWS & Cooler Series | \$25.39 |
| | — | Cartridge — refer to cartridge section | |
| 2 | 52-180016/ 70020253772 | Head & Bracket Assy. For Full Flow Series | \$35.86 |

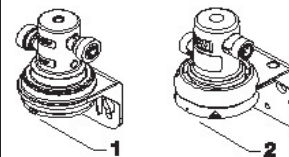

APUV12

| Part Number/ 3M ID | Description | UPC Code | List Price (ea) |
|--------------------------|-----------------|--------------|-----------------|
| UVLB-1X/ 70020102128 | Bulb Assembly | 016145062117 | \$184.45 |
| UVQS-1X/ 70020102136 | Sleeve Assembly | 016145062124 | \$111.85 |
| UVSOL-1X/ 70020056845 | Solenoid/Valve | 016145029769 | \$80.54 |
| UVCTL-1X/ 70020056803 | Control Comp | 016145029721 | \$805.08 |
| UVWH-1/ 70020228089 | Wiring Harness | 016145209598 | \$67.56 |
| UVBA-1X/ 70020102110 | Ballast | 016145062100 | \$124.49 |

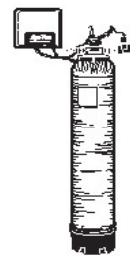

APUV24

| Part Number/ 3M ID | Description | UPC Code | List Price (ea) |
|-------------------------|---------------|--------------|-----------------|
| 5605841/ 70020018852 | Bulb | 016145107665 | \$224.44 |
| 5605842/ 70020018944 | Sleeve | 016145107672 | \$136.73 |
| 5605860/ 70020018969 | Ballast | 016145008313 | \$775.01 |
| 5605862/ 70020018985 | O-rings | 016145008337 | \$2.71 |
| 5605865/ 70020019009 | Circuit Board | 016145008344 | \$921.84 |

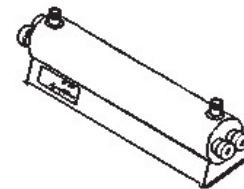

APUV65

| Part Number/ 3M ID | Description | UPC Code | List Price (ea) |
|-------------------------|---------------|--------------|-----------------|
| 5605841/ 70020018860 | Bulb | 016145107665 | \$224.44 |
| 5605842/ 70020018944 | Sleeve | 016145107672 | \$136.73 |
| 5605860/ 70020018969 | Ballast | 016145008313 | \$775.01 |
| 5605862/ 70020018985 | O-rings | 016145008337 | \$2.71 |
| 5605863/ 70020018993 | Circuit Board | 016145008344 | \$921.84 |

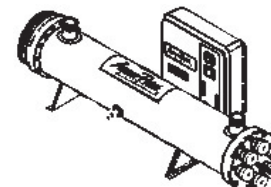

SS4/SS8/SS12/SS20 and SS EPE-316L SERIES WHERE SPECIFIED

| Item No. | Part Number/3M ID | Description | List Price (ea) |
|----------|----------------------|---|-----------------|
| 1 & 2 | 3756333C/70020092113 | Cover clamp, bolt & nut (BOTH SERIES) | \$157.27 |
| 4 | 3787201C/70020091800 | Cover (less plug) | \$229.99 |
| 5 | 3792031C/70020088194 | Gasket (shell) (BOTH SERIES) | \$24.13 |
| 6 | 6710501/70020090786 | Locking knob (BOTH SERIES) | \$11.85 |
| 7A | 6453201C | Pressure Plate SS20 | \$66.05 |
| 7B | 6453203 | Pressure plate SS4/SS8/SS12 (EPE-316L ONLY) | \$146.33 |
| 7C | 6453204 | Pressure Plate SS20 (EPE-316L ONLY) | \$109.86 |
| 8 | — | Cartridges — refer to cartridge section | |
| 9 | 6681709/70020219997 | Cartridge post — SS4 | \$44.07 |
| 9A | 6681710C | Cartridge post — SS8 | \$49.46 |
| 9B | 6681711C/70020084599 | Cartridge post — SS12 | \$58.72 |
| 9C | 6681712C | Cartridge post — SS20 | \$58.72 |
| 9F | 6681715 | Cartridge post — SS12 EPE-316L | \$86.25 |
| 11 | 6501101C | Center rod — SS4 | \$345.94 |
| 11A | 6501102C | Center rod — SS8 | \$372.63 |
| 11B | 6501103C | Center rod — SS12 | \$398.37 |
| 11C | 6501104C | Center rod — SS20 | \$428.35 |
| 11D | 6017535 | Center rod — SS4 EPE-316L | Contact Factory |
| 11E | 6017536 | Center rod — SS8 EPE-316L | Contact Factory |
| 11F | 6017537 | Center rod — SS12 EPE-316L | Contact Factory |
| 11G | 6017538 | Center rod — SS20 EPE-316L | Contact Factory |
| 12 | 9903104C/70020092121 | T-bolt & nut kit (BOTH SERIES) | \$56.89 |

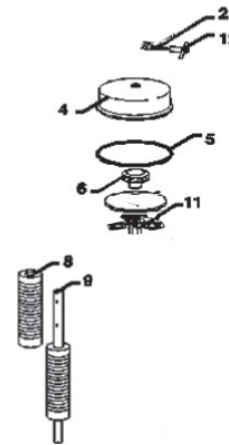

SS24/SS36 and SS EPE-316L SERIES WHERE SPECIFIED

| Item No. | Part Number/ 3M ID | Description | List Price (ea) |
|-----------|-----------------------|---|-----------------|
| 101 & 102 | 3756335C/70020126127 | Cover clamp & nut (BOTH SERIES) | \$620.58 |
| 103 | 6409632C/70020126259 | 1/4" NPT plug | \$15.98 |
| 103A | 63292-35 | 1/4" NPT plug (EPE-316L ONLY) | Contact Factory |
| 105 | 6347532C/70020126242 | Gasket (shell) (BOTH SERIES) | \$111.56 |
| 106 | 6347901C/7002016044 | Locking knob | \$246.48 |
| 106A | 6347903 | Locking knob (EPE-316L ONLY) | Contact Factory |
| 107 | 6346433C/70020126234 | Pressure plate | \$316.88 |
| 107A | 6346443 | Pressure plate (EPE-316L ONLY) | Contact Factory |
| 108 | — | Cartridge — refer to cartridge section | |
| 109 | 6681702C/70020083674 | Cartridge post — SS24 | \$29.05 |
| 109B | 6681706/70020083666 | Cartridge post — SS24 EPE-316L | \$72.06 |
| 109C | 6681707/70020013689 | Cartridge post — SS36 EPE-316L | \$66.08 |
| 111 | 6346202C/70020126218 | Center rod — SS24 | \$204.27 |
| 111C | 6346207 | Center rod — SS36 | Contact Factory |
| 112 | 6343702C/70020082940 | Spring & seal plate assy. | \$23.98 |
| 112A | 6343707/70020013614 | Spring & seal plate assy. (EPE-316L ONLY) | \$55.08 |
| 113 | 9903107C/70020159052 | T-Bolt and Nut Kit | \$131.41 |

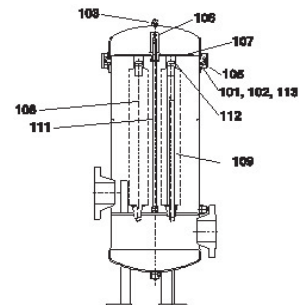

AP200/AP210

| Item No. | Part Number/ 3M ID | Description | List Price (ea) |
|----------|--------------------------|---|-----------------|
| 1 & 2 | 6875601* | Head assembly | \$62.35 |
| 1 | 6858631/ 70020021567 | Head | \$39.25 |
| 2 | 5568201/ 70020015320 | Mounting bracket | \$12.51 |
| 3 | 6462331/ 70020021237 | Housing | \$51.24 |
| 4 | 3685135/ 70020014190 | Gasket | \$5.30 |
| 4A | 3507675C/ 70020024546 | Gasket (for filters mfd. before 7/1/79) | \$5.97 |

*Includes head, mounting bracket, screws. Replaces part number 65452.31.

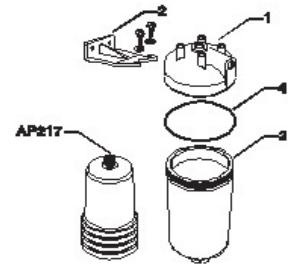

AP300/AP300B/AP305/AP450/AP450B

| Item No. | Part Number/ 3M ID | Description | List Price (ea) |
|----------|-------------------------|--|-----------------|
| 5 | 6204332/ 70020021013 | Bracket (AP305), valved | \$34.36 |
| 6 | — | Cartridge (AP317) — refer to cartridge section | |

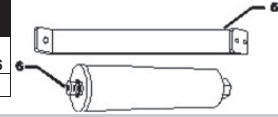

AP310/AP-DWS310

| Item No. | Part Number/ 3M ID | Description | List Price (ea) |
|----------|---------------------------|--|-----------------|
| 1 | 36-3090/ 70020024678 | Bracket Mounting | \$4.85 |
| 2 | 6841411/ 70020021427 | Installation Kit | \$5.86 |
| 3 | 52-551313/ 70020002997 | Plastic SQC head | \$24.50 |
| 4 | 6897432/ 70020008044 | Shut off valve | \$14.93 |
| 5 | — | Cartridge (AP327) — refer to cartridge section | |
| 6 | 6221545/ 70020238823 | Faucet | \$60.00 |

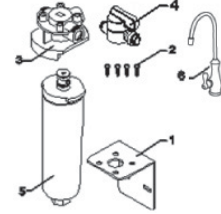

AP430SS

| Item No. | Part Number/ 3M ID | Description | List Price (ea) |
|----------|-------------------------|--|-----------------|
| 1 | 6838732/ 70020021385 | Head | \$98.41 |
| 2 | — | Cartridge (AP431) — refer to cartridge section | |

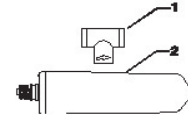

AP500

| Item No. | Part Number/ 3M ID | Description | List Price (ea) |
|----------|--------------------------|--|-----------------|
| 1 | — | Cartridge — refer to cartridge section | |
| 2 | 63597205/ 70020022532 | Gasket | \$2.35 |
| 3 | 6856702/ 70020002740 | Head assembly | \$79.33 |
| 5 | 5551501/ 70020014612 | Mounting bracket | \$9.81 |

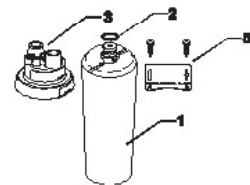

AP510

| Item No. | Part Number/ 3M ID | Description | List Price (ea) |
|----------|-------------------------|--|-----------------|
| 1 | 6856702/ 70020002740 | Head assembly | \$79.33 |
| 2 | — | Cartridge (AP517) — refer to cartridge section | |
| 3 | 6896331/ 70020002765 | Mounting bracket | \$9.42 |

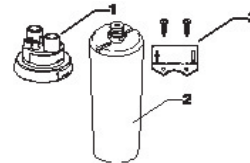

AP2100

| Item No. | Part Number/ 3M ID | Description | List Price (ea) |
|----------|--------------------------|---|-----------------|
| 1 | 3756333C/ 70020092113 | Cover clamp & nut | \$157.27 |
| 2 | 3424932C/ 70020024520 | Petcock | \$4.44 |
| 3 | 3787201C/ 70020091800 | Cover | \$229.99 |
| 4 | 3792031C/ 70020088194 | Cover gasket | \$24.85 |
| 5 | 6977201C | Compression knob | \$112.84 |
| 6 | 6978131C | Thrust washer | \$2.11 |
| 7 | 6977701C | Center rod | \$106.96 |
| 9 | 3702334C/ 70020125947 | Center post | \$62.09 |
| 10 | 6977301 | Sump | \$1,207.12 |
| 11 | — | Cartridge (AP2150) — refer to cartridge section | |
| 12 | 6409634/ 70020126267 | Pipe Plug | \$17.55 |

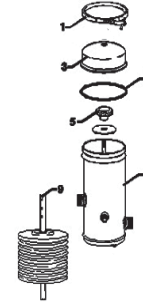

APCRF/APC77/APC78

| Item No. | Part Number/ 3M ID | Description | List Price (ea) |
|-----------|-------------------------|--|-----------------|
| — | 6996831/ 70020022441 | Self-piercing water valve (Not Shown) | \$13.12 |
| 2 | 5568201/ 70020015320 | Bracket | \$12.51 |
| 4A | 3685135 70020014190 | O-ring gasket | \$5.30 |
| 5 | — | Cartridge (C77/C78) — refer to cartridge section | |
| not shown | 6221545/ 70020238823 | Faucet | \$60.00 |
| not shown | 6884531/ 70020021724 | Outlet elbow | \$11.95 |



APIL3

| Item No. | Part Number/ 3M ID | Description | List Price (ea) |
|----------|---------------------------|---|-----------------|
| 1 | 74-985001/ 70020029214 | Quick connect male connections | \$1.50 |
| 4 | — | Cartridge (APILR3) — refer to cartridge section | |

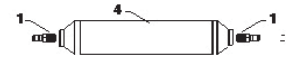

AP-DWS700/AP-DWS750

| Item No. | Part Number/ 3M ID | Description | List Price (ea) |
|----------|--------------------------|---|-----------------|
| 1 | 6856702/ 70020002740 | Head assembly | \$79.33 |
| 2 | — | Cartridge (DW85) — refer to cartridge section | |
| 3 | 6896331/ 70020002765 | Mounting bracket | \$9.42 |
| 4 | 6221545/ 70020238823 | Faucet | \$60.00 |
| 5 | 60-90411/ 70020027846 | Flow control assembly | \$18.18 |

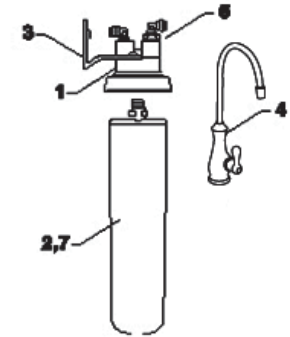

AP-DWS1000

| Item No. | Part Number/3M ID | Description | List Price (ea) |
|----------|-----------------------|---|-----------------|
| 1 | 6996831/70020022441 | Self-piercing water valve — OBSOLETE | |
| 2 | 82-11203/70020030089 | 1/4" Inlet yellow tubing* (price per ft.) | \$0.33 |
| 3 | — | Cartridge — refer to cartridge section | |
| 4 | 82-11202/70020030071 | 1/4" Inlet blue tubing* (price per ft.) | \$0.46 |
| 5 | 62215-45/70020238823 | Faucet | \$70.14 |
| 6 | 6884131/70020021708 | Shroud | \$47.57 |
| 7 | 6887101/70020021807 | Head | \$72.06 |
| 8 | 85-400201/70020030410 | UTC Shroud Mounting Pin | \$0.10 |
| 9 | 6884531/70020021724 | 3/8" NPT x 1/4" tube elbow | \$11.94 |
| 10 | 6887331/70020021823 | 1/4" NPT adapter x 1/4" tube | \$13.89 |
| 12 | 6887033/70020021799 | Metering valve | \$111.88 |
| 13 | 6980434/70020022235 | Metering valve screw (need 4 each) | \$0.41 |

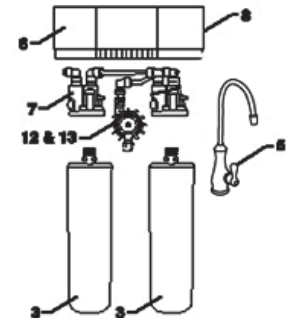

*Must order minimum of 10 ft.

APRO5000

| Item No. | Part Number/ 3M ID | Description | List Price (ea) |
|-----------|----------------------------|---|-----------------|
| 1 | — | Cartridge (AP110) — refer to cartridge section | |
| 2 | — | Cartridge (AP117RO) — refer to cartridge section | |
| 3 | 5557102/ 70020014836 | RM-TFC Membrane | \$381.93 |
| 3B | 5608401/ 70020019231 | High Flow RO Module | \$200.00 |
| 4 | 5581534/ 70020015742 | 10" filter housing and head | \$61.41 |
| 5 | 5581535/ 70020015759 | O-ring — 10" filter housing | \$5.84 |
| 6 | | SFC flow control STD — Call Technical Services for info | |
| 7 | 5581537/ 70020015775 | Union, 1/4" | \$3.80 |
| 9 | 5581539/ 70020015791 | Clip 2" | \$3.80 |
| 14 | 5581544/ 70020015825 | Faucet adapter, 3/8" | \$9.35 |
| 15 | 5581545/ 70020015833 | Drain saddle, complete | \$16.32 |
| 17 | 5581547/ 70020125970 | % rejection monitor w/probes — OBSOLETE | |
| 18 | 5581548/ 70020015858 | Storage tank w/bladder | \$184.87 |
| 20 | 60-23298/ 70020124148 | Ball valve, 1/4" | \$13.07 |
| not shown | 74-3310604/ 70020028950 | 3/8 x 1/4" reducing coupler | \$6.50 |

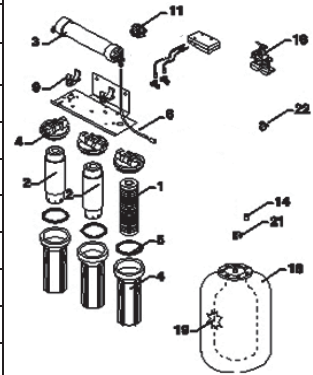

AP-RO5500

| Item No. | Part Number/ 3M ID | Description | List Price (ea) |
|----------|---------------------------|--|-----------------|
| 1 | 5608401/ 70020019231 | AP5500RM Membrane | \$200.00 |
| 2 | | Cartridges (AP5527) — refer to cartridge section | \$148.86 |
| 3 | 60-90119/ 70020027754 | Automatic shut off assembly | \$49.45 |
| 4 | 52-318212/ 70020026434 | SFC Tubing | \$16.28 |
| — | 56-18125/ 70020170745 | Tank (Not Shown) | \$53.17 |

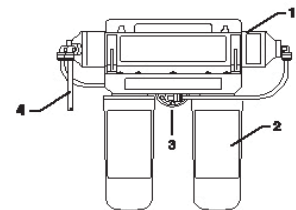

Drinking Water System and Reverse Osmosis Accessories

GEN 1 INSTALL KIT

| Item No. | Part Number/ 3M ID | Description | List Price (ea) |
|----------|-------------------------|-------------------|-----------------|
| — | 50-4009/ 70020142918 | Gen I Install Kit | \$171.53 |

ALL TUBING

| Item No. | Part Number/3M ID | Description | List Price (ea) |
|----------|------------------------|---|-----------------|
| — | 82-11202/70020030071 | 1/4" Blue Polyethylene Tubing (per ft.) | \$0.47 |
| — | 82-11201/70020030063 | 1/4" Black Polyethylene Tubing (per ft.) | \$0.57 |
| — | 82-11302/70020030121 | 3/8" Blue Polyethylene Tubing (per ft.) | \$0.85 |
| — | 82-1934101/70020030188 | 3/8" O.D. Black Polyethylene Tubing (per ft.) | \$0.77 |
| — | 82-1946101/70020030196 | 1/2" O.D. Black Polyethylene Tubing (per ft.) | \$1.55 |
| — | 81-4308/70020030006 | 1/2" Hose, PVC, Braided (per ft.) | \$2.78 |

ALL JOHN GUEST® QUICK-CONNECT FITTINGS

| Item No. | Part Number/ | Description | List Price (ea) |
|----------|----------------------------|-------------------|-----------------|
| — | 74-3350404/ 70020028992 | 1/4" Stem Adapter | \$1.30 |

CALP40/80 (All connections & tubing are available in R/O accessories section)

| Item No. | Part Number/ 3M ID | Description | List Price (ea) |
|----------|----------------------------|--|-----------------|
| 1 | 66-4307/ 70020028307 | Membrane (CALP40) | \$377.65 |
| 2 | 66-4311/ 70020028331 | Membrane (CALP80) | \$699.07 |
| 3 | 5620404/ 70020162759 | Cartridge (AP110) — refer to cartridge section | \$37.54 |
| 4 | 5541705/ 70020107010 | Cartridge (AP117) — refer to cartridge section | \$88.44 |
| 5 | 45-1111111 70020024769 | Filter housing 10" x 1/4", blue | \$58.57 |
| 6 | 45-3920133/ 70020024876 | Bracket for 10" filter housing | \$16.78 |
| 8 | 52-3165871/ 70020028400 | Flow control CALP80 | \$113.15 |
| 9 | 74-18504/ 70020028802 | Hex Nipple 1/4" | \$3.30 |
| 10 | 60-90119/ 70020027754 | Shut-off valve (only) for LP | \$49.45 |
| 11 | 53-9912/ 70020026921 | Shut-off valve for LP (inc. fitting & check valve) | \$78.43 |
| 12 | 60-6311121/ 7002027655 | Pressure regulator | \$91.42 |

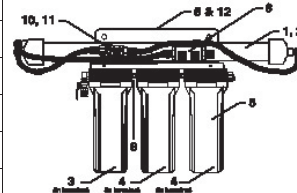

CAHP UNITS

| Item No. | Part Number/ SM ID | Description | List Price (ea) |
|----------|----------------------------|--|-----------------|
| 2 | 66-27120/ 70020028042 | TFC Module for CAHP300 | \$971.71 |
| 3 | 66-27225/ 70020028075 | TFC Module for CAHP600 (x2 for HP1200) | \$1,384.87 |
| 6 | 66-1307/ 70020027978 | TFC Membrane for CAHP150 | \$298.39 |
| 7 | 66-1311/ 70020027986 | TFC Membrane for CAHP300 | \$525.48 |
| 8 | 66-13151/ 70020028000 | TFC Membrane for CAHP600 (x2 for HP1200) | \$807.99 |
| 12 | 53-5107/ 70020026848 | Flow Control CAHP300 | \$113.15 |
| 13 | 53-5109/ 70020026855 | Flow Control CAHP600/900/1200 | \$113.15 |
| 14 | 89-1210501/ 70020030535 | Pump for CAHP150-600 | \$325.88 |
| 16 | 89-2302/ 70020030691 | Motor for CAHP150-600 | \$320.12 |
| 17 | 89-21155/ 70020030675 | Motor for CAHP900-CAHP1200 | \$398.80 |
| — | 61-110/ 70020027887 | Air Gap — Gap a flow | \$56.28 |
| 18 | 54-1115/ 70020027028 | Manifold CAHP series | \$324.73 |
| 19 | 60-6311123/ 70020027671 | Product Relief Valve CAHP series | \$146.22 |
| 20 | 60-633232/ 70020027689 | Pressure Control Valve CAHP300-900 | \$320.08 |
| 21 | 95-223424/ 70020030931 | Pressure gauge for prefilter assy. | \$88.56 |
| 23 | 24-1112/ 70020023803 | Low pressure switch | \$193.20 |
| 24 | 24-1117/ 70020023829 | Tank pressure switch | \$88.57 |
| 26 | 24-23155/ 70020023894 | Switch Float Assy, NMRO (plug type) | \$379.70 |

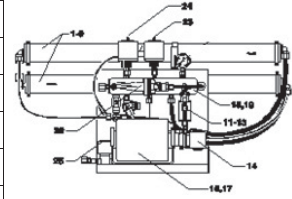

UV Pure® Ultraviolet Replacement Parts

Hallett® Series

| Part Number/ 3M ID | UPC | Description | List Price (ea) |
|-------------------------|----------------|--|-----------------|
| 6231529/ 70020226307 | 00016145208454 | 1" Flexible stainless steel hose, Hallett® 15xs/30 & Upstream™ | \$44.56 |
| 6231501/ 70020226026 | 00016145208171 | 2 lamps, SM, Hallett® 13 & Upstream™ 10-75 | \$153.82 |
| 6231502/ 70020226034 | 00016145208188 | 2 lamps, MED, Hallett 15xs & Upstream™ 10-50, 15-75 | \$180.34 |
| 6231503/ 70020226042 | 00016145208195 | 2 lamps, LG, Hallett 30 1"/1.5", Upstream™ 15-50 & 30 1"/1.5" | \$233.39 |
| 6231504/ 70020226059 | 00016145208201 | Wireless Monitor, Hallett 15xs & all Upstream™ | \$180.34 |
| 6231505/ 70020226067 | 00016145208218 | Hallett® Diagnostic Tool | \$371.30 |
| 6231506/ 70020226075 | 00016145208225 | Quartz sleeve, Hallett 13 | \$153.83 |
| 6231507/ 70020226083 | 00016145208232 | Purge Valve Assembly | \$306.60 |
| 6231508/ 70020226091 | 00016145208249 | Purge valve repair kit, Hallett 15xs | \$185.66 |
| 6231509/ 70020226109 | 00016145208256 | Wiper Motor kit, Hallett 13 & 30 1"/1.5" | \$141.10 |
| 6231510/ 70020226117 | 00016145208263 | Wiper Motor kit, Hallett 15xs & all Upstream | \$38.99 |
| 6231511/ 70020226125 | 00016145208270 | Sensor Array, complete, Hallett 13 | \$461.49 |
| 6231512/ 70020226133 | 00016145208287 | Pack of 6 fuses, Hallett 13 & 30 1"/1.5" | \$8.49 |
| 6231513/ 70020226141 | 00016145208294 | Pack of 6 fuses, Hallett 15xs & all Upstream | \$27.58 |
| 6231514/ 70020226158 | 00016145208300 | Power Conditioner, all Hallett & Upstream | \$58.35 |
| 6231515/ 70020226166 | 00016145208317 | Seals kit, Hallett 13 | \$29.71 |
| 6231516/ 70020226174 | 00016145208324 | Seals kit, Hallett 15xs & all Upstream | \$29.71 |
| 6231517/ 70020226182 | 00016145208331 | Circuit board for Hallett 13 & 30 1"/1.5" | \$265.23 |
| 6231518/ 70020226190 | 00016145208348 | Ballast for Hallett 13 & 30 1"/1.5" | \$419.06 |
| 6231519/ 70020226208 | 00016145208355 | Circuit board/ballast, Hallett 15xs | \$477.41 |
| 6231520/ 70020226216 | 00016145208362 | Remote Monitor (Handheld Only) | \$158.07 |
| 6231521/ 70020226224 | 00016145208379 | Reflector Kit Sold as each — Hallett 13 | \$116.70 |
| 6231522/ 70020226232 | 00016145208386 | Reflector Kit Sold as 1 Pair — Hallett 15xs | \$118.82 |
| 6231523/ 70020226240 | 00016145208393 | Reflector Kit Sold as each — Hallett 30 | \$171.87 |
| 6231524/ 70020226257 | 00016145208409 | Wiper Assembly — Hallett 13 | \$275.83 |
| 6231525/ 70020226265 | 00016145208416 | Wiper Assembly — Hallett 15xs | \$214.30 |
| 6231526/ 70020226273 | 00016145208423 | Wiper Assembly — Hallett 30 | \$331.00 |
| 6231527/ 70020226281 | 00016145208430 | Membrane Switch — Hallett 13 & 30 | \$50.92 |
| 6231528/ 70020226299 | 00016145208447 | 3/4" Flexible SS Hose each — Hallett 13 | \$29.71 |
| 6231529/ 70020226307 | 00016145208454 | 1" Flexible stainless steel hose, Hallett 15xs/30 & Upstream | \$44.56 |
| 6231530/ 70020226315 | 00016145208461 | 1-1/2" Flexible SS Hose each — Hallett 30 1.5" | \$111.39 |
| 6231531/ 70020226323 | 00016145208478 | 3/4" Solenoid Shut-off Valve — Hallett 13 | \$155.94 |
| 6231532/ 70020226331 | 00016145208485 | 1" Solenoid shut-off valve, Hallett 15xs & 30 & Upstream | \$155.94 |
| 6231533/ 70020226349 | 00016145208492 | 1-1/2" Solenoid Shut-off Valve — Hallett 30 1.5" | \$530.44 |
| 6231534/ 70020226356 | 00016145208508 | Blower for reactor cooling (kit), Hallett 15xs & all Upstream | \$37.13 |
| 6231535/ 70020226364 | 00016145208515 | Filter for fan, Hallett 15xs & Upstream | \$11.14 |
| 6231536/ 70020226372 | 00016145208522 | Top SS Manifold/Thermistor/Purge Valve — Hallett 15xs | \$251.43 |
| 6231537/ 70020226380 | 00016145208539 | Bottom SS Manifold — Hallett 15xs & Cactus™ X-8 & X-12 | \$132.61 |
| 6231538/ 70020226398 | 00016145208546 | Air Thermistor Replacement Kit — Hallett 15xs | \$53.05 |
| 6231539/ 70020226406 | 00016145208553 | Circuit board cooling fan, all Hallett & Upstream | \$14.85 |
| 6231546/ 70020226471 | 00016145208621 | Seals kit, Hallett 30 1"/1.5" | \$29.71 |
| 6231547/ 70020226919 | 00016145209024 | Quartz sleeve, Upstream™ 10-75 | \$153.83 |
| 6231548/ 70020226489 | 00016145208638 | Quartz sleeve, Hallett 15xs | \$153.83 |
| 6231549/ 70020226497 | 00016145208645 | Quartz sleeve, Upstream™ 15-50, 30-75, 30-75 1.5" | \$153.83 |

Hallett® Series

| Part Number/ 3M ID | UPC | Description | List Price (ea) |
|-------------------------|----------------|---|-----------------|
| 6231550/ 70020226505 | 00016145208652 | Purge valve repair kit, all Upstream™ | \$110.33 |
| 6231553/ 70020226539 | 00016145208683 | Circuit board/ballast, Upstream™ 10-75 | \$477.41 |
| 6231554/ 70020226547 | 00016145208690 | Circuit board/ballast, Upstream™ 10-50 | \$477.41 |
| 6231555/ 70020226554 | 00016145208706 | Circuit board/ballast, Upstream™ 15-75 | \$477.41 |
| 6231556/ 70020226562 | 00016145208713 | Circuit board/ballast, Upstream™ 15-50 | \$477.41 |
| 6231557/ 70020226570 | 00016145208720 | Circuit board/ballast, Upstream™ 30-75 | \$477.41 |
| 6231558/ 70020226588 | 00016145208737 | Circuit board/ballast, Upstream™ 30-75 1.5" | \$477.41 |
| 6231570/ 70020229095 | 00016145210624 | Quartz sleeve, Hallett® 30 | \$153.83 |
| 6231540/ 70020226414 | 00016145208560 | Lamp Socket Wire Harness — Hallett® 15xs | \$35.55 |
| 6231541/ 70020226422 | 00016145208577 | Top or Bottom Cap — Hallett 15xs | \$21.22 |
| 6231542/ 70020226430 | 00016145208584 | Cabinet Door Assembly — Hallett 15xs | \$111.39 |
| 6231543/ 70020226448 | 00016145208591 | Sensor Array Replacement Kit — Hallett 15xs | \$461.49 |
| 6231544/ 70020226455 | 00016145208607 | Sensor Array Replacement Kit — Hallett 30 | \$461.49 |
| 6231545/ 70020226463 | 00016145208614 | 1" Solenoid Shut-off Valve — Hallett 30 1" | \$159.12 |
| 6231552/ 70020226521 | 00016145208676 | Sensor Array Replacement Kit — Upstream™ | \$317.21 |
| 6231559/ 70020226596 | 00016145208744 | Reflector Kit — Upstream™ NC 10-75, NC 10-75 MV | \$118.82 |
| 6231560/ 70020226604 | 00016145208751 | Reflector Kit — Upstream™ NC 15-50, NC 15-50 MV, NC 30-75 | \$118.82 |
| 6231561/ 70020226612 | 00016145208768 | Wiper Assembly Kit (incl seals) NC 10-75, NC 10-75 MV | \$214.30 |
| 6231562/ 70020226620 | 00016145208775 | Wiper Assembly Kit (incl seals) NC 15-50/MV NC 30-75 | \$214.30 |
| 6231564/ 70020226646 | 00016145208799 | Cabinet Door Assembly — NC 10-75, NC 10-75 MV | \$60.47 |
| 6231565/ 70020226653 | 00016145208805 | Cabinet Door Assembly — NC 10-50, NC 10-50 MV | \$60.47 |
| 6231566/ 70020226661 | 00016145208812 | Cabinet Door Assembly — NC 15-75, NC 15-75 MV | \$60.47 |
| 6231567/ 70020226679 | 00016145208829 | Cabinet Door Assembly — NC 15-50, NC 15-50 MV | \$60.47 |
| 6231568/ 70020226687 | 00016145208836 | Cabinet Door Assembly — NC 30-75 1" | \$60.47 |
| 6231569/ 70020226695 | 00016145208843 | Cabinet Door Assembly — NC 30-75 1.5" | \$60.47 |
| 6231575/ 70020231257 | 00016145213502 | Hose Assembly | \$122.00 |
| 6231576/ 70020232925 | 00016145214660 | Flow Restrictor | \$291.75 |
| 6231578/ 70020236520 | 00016145216596 | Upstream™ Valve Assy 24v 1.5" | \$530.44 |
| 6231579/ 70020236538 | 00016145216602 | R-Series Circuit Board | \$265.23 |
| 6231580/ 70020254374 | 00016145237744 | 4-20mA Device DW — EXTERNAL | \$848.72 |
| 6231581/ 70020254630 | 00016145237973 | Lamps for Cactus™ X-8 | \$137.91 |
| 6231582/ 70020253897 | 00016145237263 | Ballast For Cactus™ X-8 & X-12 | \$318.26 |
| 6231583/ 70020253905 | 00016145237270 | Quartz Sleeve Replacement Kit for Cactus X-8 | \$95.47 |
| 6231584/ 70020253913 | 00016145237287 | Anti-fouling Kit for Cactus X-8 & X-12 | \$51.46 |
| 6231585/ 70020253921 | 00016145237294 | Stainless Steel Manifold — Top for Cactus X-8 & X-12 | \$137.91 |
| 6231593/ 70020267962 | 00016145250569 | Reflector Kit (Sold in Pairs) for Cactus X-8 | \$112.24 |
| 6231586/ 70020253939 | 00016145237300 | Reflector Kit (Sold in Pairs) for Cactus X-12 | \$112.24 |
| 6231587/ 70020253947 | 00016145237317 | Door Safety Switch for Cactus X-8 & X-12 | \$5.57 |
| 6231588/ 70020253954 | 00016145237324 | Plastic Cabinet Door (Ballast Enclosure) for Cactus X-8 | \$57.19 |
| 6231589/ 70020256932 | 00016145240133 | Plastic Cabinet Door (Ballast Enclosure) for Cactus X-12 | \$57.19 |
| 6231590/ 70020253962 | 00016145237331 | Seal Kit for Cactus X-8 & X-12 | \$13.00 |
| 6231591/ 70020253970 | 00016145237348 | Flow Restrictor Kit for Cactus X-8 | \$53.03 |
| 6231592/ 70020253988 | 00016145237355 | Flow Restrictor Kit for Cactus X-12 | \$53.03 |

PURWATER™ Replacements/Accessories

| Model Number | Part Number /3M ID | | Description | UPC Code | List Price |
|----------------------|--------------------------------|---|---|--------------|-----------------|
| TFM50EM | TFM50EM/ 70020055797 | 1 | 50 gpd | 092498003748 | \$210.74 |
| H20H-8 | H20H-8/ 70020051242 | 1 | N/A | 016145024382 | \$80.59 |
| CFB-6 | CFB-6/ 70020048487 | 1 | Mounting Bracket – FHT-34-S, FHO-34-S, FHT-34SS-S, FHO-34-SS-S, USOM-38-S, UST-38, USO-14-S | 016145021701 | \$19.85 |
| CFB-7 | CFB-7/ 70020048495 | 1 | Mounting Bracket – FHOB2-15-S, FHOB2-15-S | 016145021718 | \$45.39 |
| CFB-10 | CFB-10/ 70020048461 | 1 | Mounting Bracket – FHO2-34-S | 016145021688 | \$18.74 |
| CFW04 | CFW04/ 70020048602 | 1 | Wrench – FHT-34-S, FHO-34-S, FHT-34SS-S, FHO-34SS-S, UST-38-S | 092498004004 | \$3.59 |
| CFW05 | CFW05/ 70020048610 | 1 | Wrench – FHOB2-15-S, FHOB2-15-S | 092498003779 | \$9.06 |
| CFW06 | CFW06/ 70020048628 | 1 | Wrench – FHO2-34-S | 092498004011 | \$3.60 |
| CFW07 | CFW07/ 70020048636 | 1 | Wrench – FHO Series | 092498004028 | \$3.60 |
| ORG005 | ORG005/ 70020053883 | 1 | O-ring – FHOB2-15-S, FHOB2-15-S | 092498003793 | \$8.51 |
| ORG006 | ORG006/ 70020053891 | 1 | O-ring – FHT-34-S, FHO-34-S | 092498003786 | \$6.90 |
| ORG008 | ORG008/ 70020053917 | 1 | O-ring – UST-38, UST-38, USO-14 | 016148026997 | \$6.90 |
| CUPPLSSLP0002 | CUPPLSSLP0002/ 700200496006 | 1 | Cartridge Coupler – 2.5"/6.35 cm Diameter Cartridge | 016145022173 | \$9.59 |
| CUPPLSSLP0001 | CUPPLSSLP0001/ 70020048990 | 1 | Cartridge Coupler – 4.5"/11.43 cm Diameter Cartridge | 016145022166 | \$13.60 |

SALES POLICIES

(Subject to change without notice)

Freight Policy

3M Purification Inc.'s delivery terms are ExWorks 3M Purification Inc.'s plant. Unless otherwise instructed, shipments will be made via ground service, with transportation charges prepaid by 3M Purification Inc. and added to Buyer's invoice.

Transportation charges for air freight shipments are the responsibility of the Buyer.

Orders for filtration products, residential water treatment products, replacement parts, and/or media may qualify for free freight allowed (FFA) under the following conditions:

1. Order must ship to a single address, with a single requested ship date.
2. All orders must be in case lot quantities.
3. Net Order Value of \$5,000 or more qualifies for FFA.
 - Each individual order is evaluated on its' own merit
4. Net Order Value of less than \$5,000 does not qualify for FFA. However, each order is then evaluated by product category based on the following criteria to determine if that portion of the order qualifies for FFA:
 - Filtration products/replacement parts: Orders of \$500 net order value or more
 - Residential water treatment products: Orders of 6 units or more or \$5,000 net order value
 - Water treatment media: Orders of less than \$5,000 do not qualify for FFA. In FFA qualifying orders that contain backwashing filter systems, the media required to load those systems will be included under FFA.
5. UV Pure® branded products and Commercial/Industrial water treatment products are not eligible for FFA and are excluded from net order values when determining FFA.

Minimum Order Value Policy

1. All orders must be in case lot quantities.
2. Minimum net order value is \$250.
3. Net order values below \$250 are subject to an automatic 20% surcharge. Replacement parts are excluded from the \$250 minimum net order value.

Expedited Order Request Policy

An expedited order is defined as any order that is requested to ship the same day or the next business day that the order is received by 3M Purification Inc. Customer Service.

All expedited order requests are subject to item availability in the 3M Purification Inc. Finished Goods warehouse.

All expedited order requests should be clearly marked as such, including the requested ship date and desired transportation method, i.e. Next day, 2nd Day, 3rd Day. Ground service is not an available option on any expedited order.

Transportation charges for ALL expedited order shipments are the responsibility of the Buyer.

Expedited order requests MUST be received by 3M Purification Inc. Customer Service no later than 1:00 PM Eastern Time in order to be considered for Same Day or Next Business Day shipping.

Order Revision Policy

An order revision request is defined as any product or quantity of

product being added to or deleted from the original order received by 3M Purification Inc. Customer Service.

All order revision requests must be received by 3M Purification Inc. Customer Service within 24 hours of receipt of the original order by 3M Purification Inc. Customer Service. 3M Purification Inc.'s ability to accommodate the order revision request is subject to the current status of the original order. If 3M Purification Inc. is unable to accommodate the revision request, the revision request will be treated as an entirely new order subject to all 3M Purification Inc. standard order policies.

All order revision requests should be clearly marked or identified as such in communication.

New/Unused Product Return Policy

Returned goods must be currently offered product, less than six months from original sale date, in full case quantity, new and unused, in original undamaged shipping packaging, free from the Buyer's price markings and company labeling. A 25% restocking fee will be applied. Returns will be inspected and, if valid, credited at original net invoice price less restock fee. If original net invoice price cannot be verified, credit will be issued at current net price less 10% and restock fee.

Minimum value for any return goods request is \$125.

No product may be returned without 3M Purification Inc.'s prior written approval on a standard 3M Purification Return Goods Authorization (RGA) document. All requests to return goods must include:

1. Original customer PO number, 3M Purification Inc. Sales Order Number, or 3M Purification Inc. Invoice number in order to verify purchase date and price
2. Serial numbers for serialized products or date code for date coded products
3. Part number and quantity to be returned
4. Reason for return

Upon approval by 3M Purification Inc., an RGA number will be issued by 3M Purification Inc. Customer Service. The RGA number must be clearly marked on all cartons/packages returned, and a copy of the RGA document must be included with the shipment. Transportation charges for product returned to 3M Purification Inc. are to be prepaid by the Buyer.

Product returned without an RGA will not be credited. In this case, the Buyer must request an RGA for these products through 3M Purification Inc. Manufacturer's Sales Representative, or at the Buyer's request, the product can be returned to the Buyer freight collect.

Warranty Return Policy

No product may be returned without 3M Purification Inc.'s prior written approval on a standard 3M Purification Inc. Return Goods Authorization (RGA) document. All requests to return goods must include:

1. Original customer PO number, 3M Purification Inc. Sales Order Number, or 3M Purification Inc. Invoice number in order to verify purchase date and price
2. Serial numbers for serialized products or date code for date coded products
3. Part number and quantity to be returned
4. Reason for return

Upon approval by 3M Purification Inc., an RGA number will be issued by 3M Purification Inc. Customer Service. The RGA number must be clearly marked on all cartons/packages returned, and a copy of the RGA document must be included with the shipment. Transportation

SALES POLICIES

(continued)

charges for product returned to 3M Purification Inc. are to be prepaid by the Buyer.

Product returned without an RGA will not be credited. In this case, the Buyer must request an RGA for these products through 3M Purification Inc. or Manufacturer's Sales Representative, or at the Buyer's request, the product can be returned to the Buyer freight collect.

Shipping Damage Claims Policy

3M Purification Inc.'s delivery terms are FOB ExWorks 3M Purification

Inc.'s plant. Delivery to a common carrier shall constitute delivery to the Buyer and all risk of loss or damage in transit shall be borne by the Buyer. All shipping damage claims, whether damage is concealed or not, are the responsibility of the Buyer. Any carton damage or shortages should be noted on the bill of lading at the time of receipt. If concealed damage or loss is noted after carrier departure, the Buyer should contact carrier immediately.

TERMS & CONDITIONS

These Terms and Conditions shall govern each product sales transaction between 3M Purification Inc. and its affiliates ("3M PI") and Buyer. Any inconsistent terms of Buyer, wherever set forth and whether oral or written, shall not be binding upon 3M PI unless agreed to by 3M PI in writing. No waiver of these Terms and Conditions or any special terms relating to this order shall be binding upon 3M PI unless agreed to in writing by 3M PI.

- 1. QUOTATIONS.** Quotations submitted by 3M PI are good for acceptance only within thirty (30) days from date of quotation unless otherwise specified. Prices quoted do not include any sales, use, excise, value added, or other similar tax. Delivery lead times contained within quotations shall be effective from the date of receipt by 3M PI of all necessary engineering and manufacturing information including approved drawings if requested by Buyer.
- 2. ACCEPTANCE.** All orders are subject to 3M PI's approval and acceptance. A written acknowledgment sent to Buyer of orders so approved shall constitute 3M PI's acceptance. 3M PI may at any time alter or suspend credit, refuse shipment, or cancel unfulfilled orders when, in 3M PI's opinion, the financial conditions of Buyer or the status of Buyer's account warrants it, or when delivery is delayed by fault of Buyer or Buyer's delinquency in payment. No order accepted by 3M PI will be subject to cancellation, termination, suspension, change, reduction, cutback or any modifications by Buyer except with 3M PI's prior written consent, which may be subject to fees as 3M PI determines.
- 3. CANCELLATION.** Orders may be canceled or deliveries deferred by Buyer only upon the condition that the Buyer assumes immediate liability for and makes prompt payment to 3M PI of all expenses incurred, charges for commitments made by 3M PI, profit on work in process, and contract value of items completed and ready for shipment.
- 4. DELIVERY.** 3M PI's delivery terms are ExWorks 3M PI's plant. Shipment schedules are approximate only and are as accurate as present conditions permit. 3M PI assumes no responsibility or liability for failure or delay in making delivery or otherwise performing hereunder when such failure or delay is due to any cause beyond its control and without its fault or negligence. If for any reason 3M PI's supply of items ordered hereunder is caused to be limited, 3M PI shall have the right to prorate the supply in such manner as 3M PI in its discretion shall determine. Delivery to a common carrier shall constitute delivery to Buyer and all risk of loss or damage in transit shall be borne by Buyer. If because of Buyer's inability to take delivery, the materials or equipment are not shipped, 3M PI may have them stored for Buyer at Buyer's expense, risk and account, and for all other purposes they shall be considered "shipped." 3M PI may make partial deliveries which Buyer shall accept and pay for at the prices quoted by 3M PI in writing. If any part of the order is not delivered by 3M PI or is not in accordance with the order, the remainder of the order and Buyer's obligation thereunder shall not be affected.
- 5. PACKAGING.** All items sold hereunder shall be packed or crated and shipped in accordance with 3M PI's best judgment. Any special packing, crating, or shipping instructions of Buyer must be noted on Buyer's original order and acknowledged by 3M PI.
- 6. INSPECTION.** Buyer shall inspect all items upon arrival and give written notice to 3M PI within ten (10) days of arrival of any claim for shortage or nonconformance with these terms. Failure to give such notice, BUYER waives all claims for such shortage or nonconformance, and Buyer shall be bound to accept and pay for all items in accordance with these terms.
- 7. RETURNS.** No product may be returned without 3M PI's prior written approval. Transportation charges are to be prepaid by Buyer. When expressly authorized by 3M PI in writing, unused non-defective products in unopened packaging may be returned to 3M PI subject to a service handling and restocking charge.
- 8. PAYMENT TERMS.** Payment terms shall be net thirty (30) days from date of invoice, unless otherwise expressly agreed in writing by 3M PI. Late charges of the lesser of one and one-half percent (1½%) per month or the maximum amount allowed by law will be assessed on invoices after the due date.
- 9. CREDITS.** If any credit amount is not used, 3M PI reserves the right to offset it against the oldest outstanding items on the account. Credits are subject to unclaimed property laws. After 3M PI applies the credit to your oldest outstanding items, if a credit balance remains on your account, the credit will be reported and paid to your state, as required by the laws of your state, and will no longer be available for use on your 3M PI account.
- 10. TAXES.** Buyer shall pay all sales, use, excise, value added or other similar taxes that may levied, assessed or otherwise become due on account of items to be delivered hereunder, unless proof of exemption is furnished to 3M PI.
- 11. REPAIRS, ALTERATIONS AND MODIFICATIONS.** If Buyer requests that 3M PI repair any 3M PI product not covered by the warranty provided in Section 12 below, such repair charges shall be at the Buyer's expense unless specifically authorized in writing by 3M PI. Any alterations or modifications to the 3M PI product by Buyer or Buyer's agents are not permitted without specific authorization in writing by 3M PI and will void the warranty and render the products non-returnable by Buyer.
- 12. WARRANTY.** 3M PI warrants that 3M PI products will conform to those written specifications set forth in 3M PI's product literature and/or on 3M PI packaging and labeling materials for

TERMS & CONDITIONS

(continued)

such products for the time period specified in such literature and materials; provided, however, that products are used in accordance with written instructions furnished by 3M PI. 3M PI shall have no obligation under this warranty with respect to 3M PI products that have been incorrectly installed, improperly maintained, or modified or damaged through misuse, abuse, accident, neglect, or mishandling by Buyer or third parties. 3M PI'S sole liability and Buyer's sole remedy under this warranty shall be, at 3M PI's sole option, for 3M PI to either repair or replace any product which, having been returned to the factory, transportation charges prepaid, has been inspected and determined by 3M PI to be defective, or to refund the purchase price paid by Buyer for such defective product. All warranty claims must be made in writing to 3M PI prior to the end of the applicable warranty time period. **THE ABOVE WARRANTY IS IN LIEU OF ANY OTHER WARRANTY, AND ALL OTHER WARRANTIES ARE HEREBY DISCLAIMED, WHETHER EXPRESSED OR IMPLIED, INCLUDING BUT NOT LIMITED TO ANY IMPLIED WARRANTY OF MERCHANTABILITY OR FITNESS FOR A PARTICULAR PURPOSE, OR ANY IMPLIED WARRANTY ARISING FROM A COURSE OF DEALING OR PERFORMANCE OR USAGE OF TRADE.**

13. **LIMITATION OF LIABILITY.** Under no circumstances shall 3M PI be liable to Buyer or any third party for any indirect, special, incidental or consequential damages, including but not limited to loss of profits, business, or revenue, arising out of or as a result of 3M PI's provision of products hereunder, including but not limited to product defects or product failure, even if 3M PI has been advised of the possibility of such damages. 3M PI's liability for direct damages will in no event exceed the price paid by the Buyer for the 3M PI product(s) giving rise to Buyer's claim for damages.
14. **TRADEMARKS.** Buyer acknowledges and agrees that "CUNO" and "3M" and any other trademarks of 3M Company ("3M Marks") and associated goodwill are 3M's exclusive property. By selling products to Buyer, 3M PI and 3M do not grant Buyer any right to use 3M Marks in connection with the resale of the products unless expressly permitted in writing by 3M. Buyer will not, at any time, contest the validity of any 3M Mark, claim any rights in any 3M Mark or do anything which, in 3M's opinion, might disparage, confuse or lessen the significance of any 3M Mark.
15. **BUYER WARRANTIES.** If Buyer makes any express or implied warranties regarding 3M PI products (or regarding Buyer products into which 3M PI products are incorporated) that differ from the warranties offered by 3M PI as set forth in Section 12 above, Buyer shall assume full responsibility for and indemnify, defend, and hold harmless 3M PI, and 3M PI's affiliates, successors, assigns, officers, directors, employees and agents from any liability, loss, damage, claim, lien, judgment, and cost, including but not limited to reasonable attorneys' fees and other litigation expenses, related to any such warranties and/or remedies offered by Buyer.
16. **INDEMNIFICATION.** Buyer indemnifies 3M PI, its affiliates, and their employees and agents (the "Indemnified Parties") for, and will defend them against, any claim, personal injury, sickness, death, liability, loss, damage, lien, judgment, and cost, including reasonable attorneys' fees and other litigation expenses (collectively referred to as "Loss") in any way related to (a) any alleged express or implied warranty by Buyer or any party to whom Buyer sells, gives or otherwise transfers Products or a product of Buyer's into which Products are incorporated that differs from 3M PI's published warranties and (b) any claim related to the use, packaging, labeling, handling, testing, marketing or sale of Products or a product of Buyer's into which Products are incorporated, except where Products are shown not to meet the then-current published specification.
17. **GENERAL.** (a) Buyer will not sell, or knowingly allow a customer to transfer, any items furnished hereunder outside the 48 contiguous United States unless (i) Buyer first notifies 3M PI in writing of the intention to so export, (ii) Buyer receives prior written approval from the authorized representative of 3M PI's International Business Development unit, and (iii) all applicable export regulations are complied with by Buyer and its customer and all applicable licenses are obtained. Buyer will offer nothing of value to any government official on behalf of 3M PI. (b) 3M PI is not responsible for typographical errors made in any of its publications or for clerical errors made in preparation of quotations, sales orders, or acknowledgments. All such errors are subject to correction by 3M PI. (c) These Terms and Conditions shall be governed by the laws of the State of Connecticut, USA, without regard to Connecticut's conflicts of law provisions. Buyer submits to the exclusive personal and subject matter jurisdiction of the Connecticut courts to resolve any disputes arising hereunder. (d) These Terms and Conditions, along with 3M PI's quotation or proposal, contain the parties' entire understanding on this subject, superseding any prior written or oral agreements, statements, communications or understandings between the parties relating to this subject matter, except that any confidential nondisclosure agreement that has been executed by and between the parties shall remain in effect in accordance with its terms.

NOTES

NOTES

Thank you for your continued support of 3M Purification Inc. as we remain committed to providing the highest quality products and services to you, our customers. We look forward to continuing to support your needs throughout 2014 and beyond.

3M

2014 Drinking Water Lead Reduction Act

To whom it may concern:

On January 4, 2014, the Reduction of Lead in Drinking Water Act will go into effect. This means that all manufacturers, distributors, builders, and plumbing contractors must comply with the new law which will affect all potable plumbing products sold or installed in the United States. It requires that all pipes, fittings and fixtures intended to convey water for human consumption through drinking or cooking, that is sold, available for sales or used in specified repair or new installations, must have a weighted average lead content less than or equal to .25% based on the average of their wetted surface areas.

As a valued customer, 3M Purification Inc wanted to assure you that we are aware of this law and have been proactively working with WQA on NSF/ANSI 372-2010 Drinking Water System Components – Lead Content for the past three years. To date over 1,600 products have been listed to this standard.

For a complete list of certified products please reference wqa.org and search for low lead compliance products.

Should you have any specific questions on parts you do not see, or have additional questions regarding compliance, please contact Donna Prete, Regulatory Affairs Manager at 203-238-8965, or by email at dmprete@mmm.com

Don't forget to check out the benefits of
the Aqua-Pure Certification Program

www.aquapure.com/justaddwater



3M Purification Inc.

400 Research Parkway
Meriden, CT 06450, U.S.A.

Tel (800) 222-7880

(203) 237-5541

Fax (203) 238-8701

www.aquapure.com • www.3mpurification.com

Please recycle. Printed in U.S.A.

3M is a trademark of 3M Company.

Aqua-Pure and Purwater are trademarks of 3M Company.

NSF is a trademark of NSF International.

All other trademarks are the property of their respective owners.

© 2013 3M Company. All rights reserved.

70020192525 REV 1113